

STREET VENDORS BYLAW

EFFECTIVE JULY 10, 1995
AMENDED MAY 23, 1996
AMENDED JULY 14, 2004
AMENDED DECEMBER 08, 2008
AMENDED MAY 11, 2015

AMENDED APRIL 23, 1998
AMENDED JANUARY 13, 2003
AMENDED MAY 11, 2006
AMENDED MAY 8, 2014
AMENDED MAY 29, 2015

Summary of Bylaw Amendments at end of Bylaw

THE COUNCIL OF THE CITY OF CHARLOTTETOWN ENACTS AS FOLLOWS:

PART I:

1. This Bylaw may be cited as the "Street Vendors Bylaw".

PART II: DEFINITIONS

2. Unless the context otherwise requires, in this Bylaw:
 - 2.1 **"Abutting Retailer"** means a person who carries on retail business from a permanent place of business abutting a sidewalk in the City and pays business taxes to the City or is a tenant of the building for which taxes are paid to the City;
 - 2.2 **"Abutting Retailer – Dining Room License Space(s)"** means a total of **24** parking spaces, approved by Council, available for consideration of applications for the installation of exterior decks in the area approved under section 9.7 (a).
 - 2.3 **"Agreement"** means all agreements mentioned in this Bylaw which shall be executed by the Mayor and Chief Administrative Officer of the City of Charlottetown;
 - 2.4 **"City"** means the City of Charlottetown, a body corporate, duly incorporated under the laws of the Province of Prince Edward Island and includes the area contained within the boundaries of the City of Charlottetown where the context so requires;
 - 2.5 **"Confectionery Tricycle"** means a manually propelled tricycle vehicle used or intended to be used for storing and transporting ice cream, ice milk and other confectionery products;
 - 2.6 **"Confectionery Tricycle Vendor"** means a person who owns and operates or who has operated for him a confectionery tricycle from which ice cream, ice milk, or other iced confectionery products are sold;
 - 2.7 **"Council"** means the municipal council of the City of Charlottetown;

STREET VENDORS BYLAW

- 2.8 **"Designated Push Cart/Food Truck Areas"** means those areas within the City designated in Schedule "A" of this Bylaw as areas in which the selling of food and/or beverages from a push cart or food truck is permitted;
- 2.9 **"Downtown Core Area"** means the area:
BOUNDED on the North by Euston Street;
ON the East by Prince Street;
ON the South by the Northern boundary of the Hillsborough Harbour; and
ON the West by the Eastern boundary of Pownal Street;
- 2.10 **"Flower Vendor"** means a person who sells flowers from a basket carried by hand;]
- 2.11 **"Food Truck/Mobile Canteen"** means is a motor-powered vehicle, not a trailer, which is no greater than 10 metres in length (33 feet), by 2.6 metres in width (8.5 feet), by 4.3 metres in height (14 feet).
- 2.12 **"Goods"** means goods, wares and merchandise and includes food and/or beverages;
- 2.13 **"Person"** means a natural person, or a body corporate, and includes a partnership, a group of persons acting in concert or an association;
- 2.14 **"Push Cart"** means a hand-operated display device used or intended to be used for transporting, storing, displaying and selling of food and/or beverages. The display device or hand-operated push cart may be towed to the site, but it must be small enough to be movable off the site by hand by the licensed operator.
- 2.15 **"Push Cart/Food Truck Vendor"** means any person who owns and operates or has operated for him a push cart/food truck from which food and/or beverages may be sold;
- 2.16 **"Residential Street"** means a street within the City of Charlottetown which is not located within the downtown core area;
- 2.17 **"Sidewalk"** means the portion of a street set aside for the use of pedestrians whether or not the surface is covered with gravel, concrete, asphalt, or other type of paving;
- 2.18 **"Street"** means any street within the boundaries of the City of Charlottetown and includes a lane, a bridge and a sidewalk;
- 2.19 **"Selling"** includes offering for sale and soliciting orders for the sale of goods.

STREET VENDORS BYLAW

PART III:

3. 3.1 No person shall park, place or permit to be parked or placed on any street, park or public place within the City any vehicle, mobile canteen, stand, van, trailer, push cart or combined unit of vehicle and trailer for the purposes of selling goods of any description except as permitted by this Bylaw.
- 3.2 No person shall expose for sale on, or sell any goods from any street, park, or public place within the City except as permitted by this Bylaw.

PART IV:

4. 4.1 This Bylaw does not apply to:
- (a) A person who sells to only wholesale or retail dealers in similar goods;
 - (b) A person who goes door-to-door selling milk, cream or fluid milk products only to the consumer;
 - (c) A farmer or fisherman resident in Prince Edward Island who goes door-to-door selling only the produce of his own farm or fish caught by him;
 - (e) A newspaper vendor who sells newspapers which he carries with him; and
 - (f) A person selling for charitable organizations or non-profit groups such as but not limited to school activities, girl guides, boy scouts, etc.
- 4.2 Notwithstanding Subsection 3.1 and 3.2 of this Bylaw:
- (a) A confectionery tricycle vendor who has been issued a license under this Bylaw may carry on business within the areas designated in Subsection 5.1, (a), (b), (c), (d) and (e) of this Bylaw;
 - (b) A push cart vendor who has been issued a license under this Bylaw may carry on business in the location designated pursuant to Subsection 5.2 of this Bylaw;
 - (c) A flower vendor may carry on business pursuant to a flower vendor's license issued pursuant to this Bylaw and within the areas designated in Subsection 5.3; and
 - (d) An abutting retailer may conduct a sidewalk sale pursuant to a permit issued under this Bylaw.

STREET VENDORS BYLAW

PART V:

5. 5.1 A confectionery tricycle vendor who has been issued a confectionery tricycle license under this Bylaw may sell ice cream, ice milk or other iced confectionery products from a confectionery tricycle for which a license has been issued under this Bylaw on any residential street within the City. Notwithstanding the foregoing, a confectionery tricycle vendor shall not carry on that business:
- (a) On any street within the downtown core area;
 - (b) On any street, or part thereof, adjacent or bordering on any public park, playground or athletic field where refreshments are available;
 - (c) Within 30 meters of any school;
 - (d) Within 30 meters of any retail establishment selling similar goods.
 - (e) Within 30 meters of any retail establishment selling similar goods.
- 5.2 A push cart or food truck vendor who has been issued a license under this Bylaw may sell those goods specified in that license from a push cart or food truck for which a license has been issued under this Bylaw in the following places within the City but in no other:
- (a) From the space in the designated push cart/food truck areas allotted to him by the Licensing Inspector under Schedule “A” of the by-law.
- 5.3 A flower vendor who has been issued a license under this Bylaw may sell flowers from a hand-carried basket in the following places but in no other:
- (a) Within the pedestrian mall; and
 - (b) Within the downtown core area.

PART VI:

6. 6.1 A confectionery tricycle vendor who has been issued a license under this Bylaw shall:
- (a) Use only a tricycle specified in a license issued to him and for which a license has been issued under this Bylaw;
 - (b) The license issued under this Bylaw must be displayed in a conspicuous place on the tricycle;

STREET VENDORS BYLAW

- (c) Equip the tricycle with a refuse container;
- (d) Use only a soft toned bell or chime on the tricycle;
- (e) Sell only ice cream, ice milk or other iced confectionery products which are wrapped and shall not sell in bulk;
- (f) Equip each driver of a tricycle with bright clean wearing apparel;
- (g) Employ drivers who are students domiciled in the City and who are:
 - (1) of the age of 16 years or over; or
 - (2) of the age of 12 years and who have first furnished the owner of the confectionery tricycle with a written consent signed by his parent or lawful guardian that he may be employed as such.
- (h) Operate or permit the tricycle to be operated during daylight hours only;
- (i) Not operate or permit the vehicle during normal elementary school hours;
- (j) Not stop or permit the confectionery tricycle to be stopped on any of the travelled portion of any street which is signed "No Parking" or "No Stopping";
- (k) Not carry on business other than in those areas within the City designated in Subsection 5.1, (a), (b), (c), (d), and (e) of this Bylaw;
- (l) Maintain the tricycle in good repair and appearance;
- (m) Park the tricycle adjacent to the curb of a sidewalk or off the travelled portion of the street or where there is no sidewalk in any place where parking is permitted pursuant to the City's Traffic Bylaw as amended from time to time;
- (n) Not sell or otherwise dispense ice cream, milk or other iced confectioneries elsewhere than on the curb side of the tricycle or on the side nearest the boundary of the street if there is no sidewalk;
- (o) Comply with all provincial or municipal health standards prescribed for the tricycle and for the manner of storing and handling the products sold therefrom;
- (p) Comply with all applicable provisions of the Highway Traffic Act R.S.P.E.I. 1974, H-6 and of the City's Traffic Bylaw as amended from time to time; and

STREET VENDORS BYLAW

- (q) Maintain any insurance required by this Bylaw in full force and effect during the currency of any license issued to him under this Bylaw.
- 6.2 A push cart or food truck vendor who has been issued a license under this Bylaw shall:
- (a) Use only a push cart or food truck specified in a license issued to him under this Bylaw;
 - (b) Not carry on business other than in the areas designated in or pursuant to Subsection 5.2 and 5.2 (a) of this Bylaw;
 - (c) Be free to operate at any hour, except where the location is in a residential area (Schedule “A” Food Truck – Space #3) which shall not vend between 12:01 a.m. and 10:00 a.m. on any day;
 - (d) Not leave any push cart or food truck unattended during business hours;
 - (e) Not store, park or leave any push cart or food truck overnight on any street other than on the pedestrian mall; and not propel the push cart after dusk unless equipped with reflector tape and lights;
 - (f) Effective September 1, 2015, Non-Styrofoam packaging and cups must be used for serving containers.
 - (g) Not sell food products for immediate consumption unless he has available for public use his own or a public litter receptacle which is available for his customers' use. Recycling receptacles must be provided for any packaging that is recyclable, if present.
 - (h) Not leave any location without first picking up, removing and disposing of all refuse remaining from sales made by him;
 - (i) Not allow anything relating to the operation of his business to be placed anywhere other than in, on or under the push cart or food truck;
 - (j) Not set up, maintain or permit the use of any table, crate, carton, rack or any other device to increase the selling or display capacity of his push cart or food truck unless the device has been referred to in his application for a license under this Bylaw and has been approved by the Licensing Inspector for use in conjunction with the push cart or food truck;
 - (k) Not solicit or conduct business with persons in motor vehicles;
 - (l) Not sell anything other than those goods which he is licensed under this

STREET VENDORS BYLAW

Bylaw to sell;

- (m) Use no loud speakers, amplifiers or other hailing devices;
- (n) Not sell or otherwise dispose of any goods elsewhere than on the curb side of the push cart or food truck or on the side of the push cart or food truck nearest the boundary of the street if there is no sidewalk;
- (o) Keep the push cart or food truck in good repair and appearance; and
- (p) Any electrical generator must be self-contained and not have a decibel output exceeding 70 Db, which shall not exceed 60 Db when tested on the property of the nearest potential complainant.
- (q) Maintain any insurance required by this Bylaw in full force and effort during the currency of any license issued to him hereunder.
- (r) In the case of a food truck ensure that the provisions of the Highway Traffic Act and the Motor Vehicle Inspection Regulations are met and maintained.

PART VII:

- 7. 7.1 This Bylaw shall be administered and enforced by a Licensing Inspector and by so many Deputy Licensing Inspectors as Council may appoint from time to time. A Deputy Licensing Inspector appointed by Council under this Bylaw shall carry out such functions and duties as may be assigned to him by the Licensing Inspector which may include carrying on the duties of the Licensing Inspector in his absence.
- 7.2 An applicant for a license under this Bylaw shall make a separate written application to the Licensing Inspector for each confectionery tricycle, push cart or food truck, as the case may be, which he intends to operate or which he intends to have operated for him.
- 7.3 An application for a license under this Bylaw shall be in a form prescribed by the Licensing Inspector and shall contain:
 - (a) The name, home and business address and telephone number of the applicant;
 - (b) A full description of the goods which the applicant intends to sell;
 - (c) A full description, and a photograph or an artist's concept, of any

STREET VENDORS BYLAW

confectionery tricycle, push cart or food truck , for which a license is sought together with the serial and registration number, if any, of the vehicle;

- (d) Three prints of a full-faced photograph of the applicant and employee(s) taken not more than 30 days prior to the date of the application.
- (e) Where applicable, the name and address of each known person the applicant has employed or the number of persons the applicant intends to employ to operate the vehicle, if any, for which a license is sought;
- (f) The designated push cart/food truck areas in which the applicant would prefer to carry on business;
- (g) The months during which the applicant intends to carry on business and his intended hours of operation; and
- (h) Such other information as the Licensing Inspector may require.

7.4 All applications for licenses shall be made after January 1, but before February 15 of each year to carry on a business under this by-law.

7.5 No license shall be issued pursuant to this Bylaw unless:

- (a) The license fee prescribed in Schedule “B” to this Bylaw has been paid;
- (b) Where applicable, the size and design of the confectionery tricycle, push cart or food truck sought to be licensed by the applicant has been approved by the Licensing Inspector;
- (c) A member of the Charlottetown Police Force has certified, in writing to the Licensing Inspector, that a confectionery tricycle for which a license is sought has been inspected by him and is mechanically safe;
- (d) The Fire Inspector of the City certifies, in writing to the Licensing Inspector, that he has inspected a push cart/food truck sought to be licensed under this Bylaw and it complies with all applicable fire standards;
- (e) A certified copy of a public liability insurance policy in a form and in an amount established and described in Schedule “C” annexed hereto which has been approved by resolution", naming the City as an additional named insured has been provided to the Licensing Inspector;
- (f) A certificate of insurance in respect of such insurance policy providing

STREET VENDORS BYLAW

that such insurance policy cannot be cancelled or terminated without sufficient prior notice has been provided to the Licensing Inspector;

- (g) A Hold Harmless Agreement has been completed and signed for any license issued to operate on City Property. Which stipulates the applicant agrees to save harmless the City of Charlottetown, from and against any and all claims, including, without limitation, all claims for death, bodily injury or property damage, arising from any act or omission of the vendor or any assignee, agent, contractor, servant, employee, invitee or licensee of the vendor and from and against all costs, counsel fees, expenses and liabilities incurred in connection with any such claim or any action or proceeding brought thereon related to the event.
- (h) Any federal, provincial or municipal permit, certificate, authority, license or other document of qualification required by the applicant in order to carry on his intended business, including any permit required under the Public Health Act R.S.P.E.I. 1979, Cap. P-29.1 and the Electrical Inspection Act R.S.P.E.I., 1974, Cap. E-2 as amended from time to time, has been obtained.

7.6 Unless otherwise provided in this Bylaw, if an applicant has complied with all the conditions of this Bylaw for the issuance of the license sought by him, the Licensing Inspector shall issue that license to the applicant.

7.7 A license to sell food and/or beverages from a push cart/food truck issued in accordance with this Bylaw shall only permit the holder thereof to operate from a location specified on that license for the display and sale of the goods described in that license.

PART VIII:

8. 8.1 If, in any year, the Licensing Inspector receives more applications from push cart/food truck vendors than there are spaces established for push carts/food trucks in designated push cart/food truck areas, then the Licensing Inspector shall issue only as many licenses as there are such spaces to those applicants who have complied with all the applicable requirements of this Bylaw for the issuance of the license, based on priorities outlined in 8.1 (a) through (c).

For the issuance of licenses, the following shall apply: applications received between January 1 and Feb 15, shall be reviewed and those complying with this Bylaw will be given consideration for a license based on the following:

- (a) Firstly, to students who have indicated that they are planning to return to school in the fall;

STREET VENDORS BYLAW

- (b) Then to local Charlottetown businesses;
- (c) Then to all other applicants.

Should the number of applications exceed the approved number of spaces, a lottery will be held based on each of the priority levels (if needed) to allocate the licenses, **based on one lottery ticket per application**. Where a lottery is required, all applicants shall be advised in advance of the date, time and place of the lottery.

- 8.2 The Licensing Inspector may also consider the following standards:
- (a) Quality in the workmanship and materials used in the construction of the push cart;
 - (b) Attractiveness in the design and coloration of the push cart;
 - (c) Quality in the goods intended to be sold; and
 - (d) Uniqueness in the goods intended to be sold.
- 8.3 Every license issued by the Licensing Inspector under this By-Law shall:
- (a) Specify the name and address of the licensee;
 - (b) Where applicable, specify the allocated space of the licensee within the pedestrian mall or designated push cart/food truck areas;
 - (c) Specify the type of goods which the licensee is licensed to sell;
 - (d) Specify the license number and the date upon which it was issued.
- 8.4 The license issued under this Bylaw shall be deemed to be in force from the 1st - day of April in the year of issue to the last day of December in the following year, provided the applicant has indicated their desire to renew the license and has paid the appropriate fee, prior to Feb 15th of the year of expiry.
- 8.5 The Licensing Inspector shall keep a record of all licenses issued under this Bylaw.
- 8.6 A license issued under this Bylaw is not transferable or assignable or eligible for resale.
- 8.7 Every licensee who has employed persons to operate a confectionery tricycle,

STREET VENDORS BYLAW

push cart or food truck for which a license has been issued under this Bylaw shall:

- (a) Supply each employee with an identification card with the name of the employee, the date of employment and the license number of the vehicle which is to be operated by him; this identification card shall be worn by the employee while he is working;
- (b) Give immediate notice to the Licensing Inspector of every person so employed by him and of the termination of employment of each such employee.

8.8 Each flower vendor to whom a license has been issued under this Bylaw shall carry that license with him at all times and shall produce it, upon request, to any police officer, Licensing Inspector or Deputy Licensing Inspector appointed by the City.

8.9 A police officer, the License Inspector or any other person authorized by Council may inspect any confectionery tricycle, push cart or food truck for which a license has been issued under this Bylaw at all reasonable times.

PART IX:

9. 9.1 An abutting retailer may make application to the Licensing Inspector for a permit to conduct a sidewalk sale of goods, beverages and/or food products for no more than two (2) days in a week. An application for such a permit shall be on a form prescribed by the Licensing Inspector and contain:

- (a) The name, address and telephone number of the applicant;
- (b) The name of the street upon which the retailer's permanent place of business abuts;
- (c) The date and time for which the permit is required;
- (d) The size and proposed location of any tables or racks or other display device intended to be used by the applicant during the sidewalk sale;
- (e) A full description of the goods intended to be sold; and
- (f) Such other information as the Licensing Inspector may require.

9.2 (a) The Downtown Charlottetown Inc. or the Chamber of Commerce may make application to the Licensing Inspector to hold sidewalk sales for the months of June, July, August and September as long as Subsection 7.1, 7.2, 7.3, 7.4, and 7.5 have been complied with; and

STREET VENDORS BYLAW

- (b) A list of abutting retailers who wish to operate a sidewalk sale shall be submitted to the City showing addresses and telephone numbers of the merchants.
- 9.3 The Planning Board shall make a decision on which day(s) of the week all retailers may hold sidewalk sales without requiring permits but there shall be no more than two days designated for sidewalk sales in one week.
- 9.4 Special requests for sidewalk sales other than the day(s) designated shall be made to the Licensing Inspector and Council may approve the special requests.
- 9.5 The Applicant shall provide such other information as the Licensing Inspector may require, including the size and proposed location of any tables, racks or other display devices to be used by the merchants for the sidewalk sales.
- 9.6 A permit may be issued under this Bylaw to an abutting retailer which shall permit the holding of a sidewalk sale of food and beverages, including alcoholic beverages, with a dining-room licence only, under the Liquor Control Act of the Province (R.S.P.E.I. 1974, Cap. L-17) in areas approved by Council south of Fitzroy Street only, provided:
- (a) The provisions of Subsection 9.1 (complete), 9.2, 9.3, 9.4 and 9.5 are complied with;
 - (b) Council has approved the use of any areas between the sidewalk and the street to be used in the sidewalk sale;
 - (c) Council has approved the closing of part or all of the travel portion of the sidewalk for a specified time;
 - (d) That an agreement be entered into with the City in a form approved by Council, which shall address, but is not limited to matters such as:
 - (1) liability insurance;
 - (2) time limits for use of the street right-of-way;
 - (3) any fees to be charged for encroachment on a street right-of-way;
 - (4) a scaled drawing showing the location of street furniture accessories and landscaping on a street; and
 - (5) hours of operation.
 - (e) The abutting retailer that holds a dining room licence pursuant to the Liquor Control Act of the Province (R.S.P.E.I. 1974, Cap. L-17) and that the abutting retailer shall only conduct its sale of food and beverages in the area on the sidewalk approved by Council;
 - (f) That no permit shall be issued to an abutting retailer under this Section

STREET VENDORS BYLAW

unless:

- (1) the applicant is seeking a permit to hold a sidewalk sale on a sidewalk abutting his permanent place of business;
- (2) the occupation of the sidewalk proposed by the applicant will not impede pedestrian traffic or block or impair the entrance to any premises abutting the area proposed to be occupied by the applicant during the sidewalk sale; and
- (3) the size and proposed location of all tables or racks or other display devices intended to be used by the applicant during the sidewalk sale has been approved by the Licensing Inspector.

- 9.7 (a) An abutting retailer that holds a dining room licence pursuant to the Liquor Control Act of the Province (R.S.P.E.I. 1974, Cap. L-17) may make application to occupy a parking space(s), **that abut their facility**, in the area bounded by; Pownal Street to the west, Hillsborough Street to the east and Fitzroy Street to the north; for the sale of food and beverage products from May 1 to October 31 of any year.

All applications for licenses shall be made after January 1, but before February 15 of each year to carry on a business under this by-law.

Establishments that are situated on a corner, with frontage on two streets, may apply for decks on both streets, however these would be separate applications. Subject to the reviewing authority, a maximum of three spaces may be considered in any application.

A license issued under this Bylaw shall be deemed to be in force from the 1st day of April in the year of issue to the last day of December in the two years following, provided the applicant has indicated their desire to renew the license and has paid the appropriate fee, prior to Feb 15th of the subsequent years.

For the purposes of clarification of subsection (a) and (b), those licenses held or approved in 2013, remain in force and effect to December 31st, 2015. Any new licenses approved in 2014 will also remain in force and effect until December 31st 2015.

- (b) Consideration of applications for licenses in any year shall be on a first received basis. Applications for licenses for spaces that are already licensed for that year shall not be considered. Should the number of applications exceed the approved number of spaces, a lottery will be held to allocate the licenses, **based on one lottery ticket per application**. Where a lottery is required, all applicants shall be advised in advance of the date, time and place of the lottery.
- (c) Any license issued shall be subject to the requirement for the Applicant to

STREET VENDORS BYLAW

enter into an agreement with the City on terms acceptable to the City, and which agreement addresses, but is not limited to the following:

- (1) liability insurance;
 - (2) Hold Harmless Agreement
 - (3) time limits for use of the street right-of-way;
 - (4) any fees to be charged for encroachment on a street right-of-way;
 - (5) a scaled drawing showing the location of street furniture accessories and landscaping on a street;
 - (6) hours of operation and space(s) approved;
 - (7) the design of the fence to be constructed pursuant to Subsection 9.7(g) of this Bylaw.
- (d) The Licensing Inspector may issue a license to an abutting retailer for one or more years but not more than three (3) years at a time. In determining the duration of the license to be issued, the Licensing Inspector may consider the expense to be incurred in constructing the required fencing around the space. If, at the expiration of a license, no new applications are received for a license for that space, then the license may be renewed by the Licensing Inspector. Council shall by resolution from time to time delete, assign new or additional spaces in the area outlined in section 9.7 (a), which may be issued licenses pursuant to this Bylaw;
- (e) In determining whether to issue a license, the Licensing Inspector shall consider, but not be limited to consideration of the quality in the workmanship and materials used in the construction of the fencing and any tables and chairs, umbrellas and displays and attractiveness in the design and coloration.
- (f) The hours of operation pursuant to any license issued are from 8:00 AM to 12:00 midnight;
- (g) Every space for which a license is issued shall require the licensee to construct a metal fence around the site in accordance with the designs contained in Schedule "D".

PART X:

10. 10.1 Subject to an appeal to Council, a license or permit issued under this Bylaw may be suspended or revoked by the Licensing Inspector:
- (a) For violation of this Bylaw;
 - (b) For violation of any other Bylaw of the City;

STREET VENDORS BYLAW

- (c) For violation of any provincial or municipal health standards;
 - (d) For violation of the Highway Traffic Act R.S.P.E.I. 1974 Cap. H-6;
 - (e) For violation of any federal, provincial or municipal laws or regulations governing business practices;
 - (f) Breach by the licensee of any agreement entered into by him and the City;
or
 - (g) On such other grounds as in the opinion of the Licensing Inspector are just and reasonable.
- 10.2 Upon a license being suspended or revoked the Licensing Inspector shall notify the licensee thereof by delivering a notice to him personally or by mailing a double registered letter to the address shown on his license and after that notice has been delivered the licensee shall not carry on his business until a new license is issued or his suspended license is reinstated.

PART XI:

11. 11.1 Any person who has been refused a license or whose license has been suspended or revoked by the Licensing Inspector may appeal such refusal, suspension or revocation to Council.
- 11.2 An appeal to Council shall be in writing, shall be filed with the City Administrator within 15 days of the receipt by the Licensee of notice of the refusal, suspension or revocation as provided by Subsection 10.2 of this Bylaw and shall clearly state the grounds for the appeal.
- 11.3 The Council shall hear such appeals at such time and place as it may determine and, upon such an appeal, Council may confirm the refusal, suspension or revocation by the License Inspector or may direct the License Inspector to issue or reinstate the license.

PART XII:

12. 12.1 A person who violates or fails to comply with the provisions of this Bylaw is guilty of an offence and is liable on summary conviction to a fine of not less than \$100 and not more than \$500 and in default of payment to imprisonment for a period not exceeding 30 days. Each day a person so operates shall comprise a separate offence.
- 12.2 Where a person is carrying on business without a license required by this Bylaw, or from a space other than the space allocated to him and specified in a license

STREET VENDORS BYLAW

issued under this Bylaw, in addition to any other remedy or penalty imposed by this Bylaw:

- (a) The City may immediately and without notice of any kind remove any vehicle or other device used in the storing, transporting, displaying or selling of goods together with any goods displayed thereon to a place selected by the City and all costs and charges incurred by the City for the removal and storage shall be a lien thereon and the City may, by action in any Court of competent jurisdiction, recover as a civil debt due to the City by the owner the cost of removal and storage thereof; and
 - (b) Each day a person so operates shall comprise a separate offence.
- 12.3 Where a person is carrying on a business in contravention of this Bylaw, then in addition to any other remedy or penalty imposed by this Bylaw the City may, in all such cases, apply to the Supreme Court of Prince Edward Island for an injunction or other order prohibiting or restraining that person from contravening this Bylaw.

PART XIII:

13. 13.1 A person licensed under this Bylaw or holding a permit hereunder shall permit employees of the City and employees of any public utility to enter upon any portion of any street which has been allocated to him under this Bylaw and which he is permitted to use for the purpose of installing, maintaining or repairing any street or part thereof or any pipes, drains, cables, wires, poles or other installations.
- 13.2 Except as otherwise specifically provided in this Bylaw or any other Bylaw of the City, nothing in this Bylaw relieves any person licensed under this Bylaw from complying with all other applicable laws.
- 13.3 Where the provisions of this Bylaw conflict with the provisions of any other Bylaw of the City, the provisions of this Bylaw shall prevail.

STREET VENDORS BYLAW

SCHEDULE "A" DESIGNATED PUSH CART/FOOD TRUCK AREAS

On specific street corners and parking meter spaces as designated by this Bylaw – otherwise, it is prohibited.

STREET VENDORS – PUSH CART SITES

See attached map for designated parking spaces

- Space 1. Single space on the southeast corner of Queen and Kent Streets intersection. Space allocated on Kent Street in parking meter space # 10R.
- Space 2. Single space on the northeast corner of Queen and Richmond Streets intersection. Space allocated on Queen Street in parking meter space # 22.
- Space 3. Single space on the southeast corner of University Avenue and Kent Street intersection. Space allocated on Kent Street in parking meter space # 24.

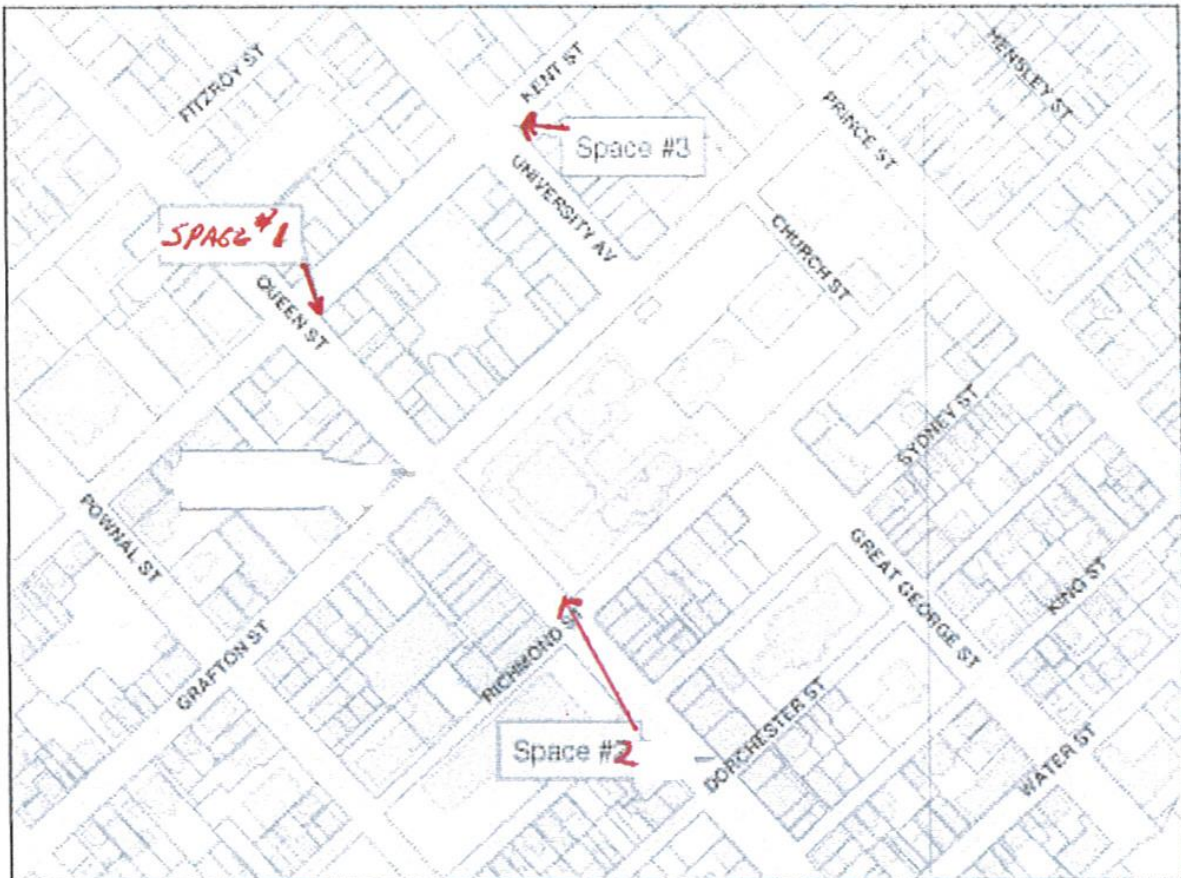

STREET VENDORS BYLAW

SCHEDULE "A" DESIGNATED PUSH CART/FOOD TRUCK AREAS

On specific street corners and parking meter spaces as designated by this Bylaw – otherwise, it is prohibited.

STREET VENDORS – FOOD TRUCK SITES See attached map for designated parking spaces

- Space 1. Space(s) on the northwest corner of Queen and Grafton Streets intersection. Space(s) allocated on Grafton Street in parking meter space # 23 L & R.
- Space 2. Space(s) on the southwest corner of Grafton and Church Streets intersection. Space(s) allocated on Church Street.
- Space 3. Space(s) on the southeast corner of Water St. and Great George St. (restricted hours, shall not vend on any day between 12:01 am and 10:00 am)

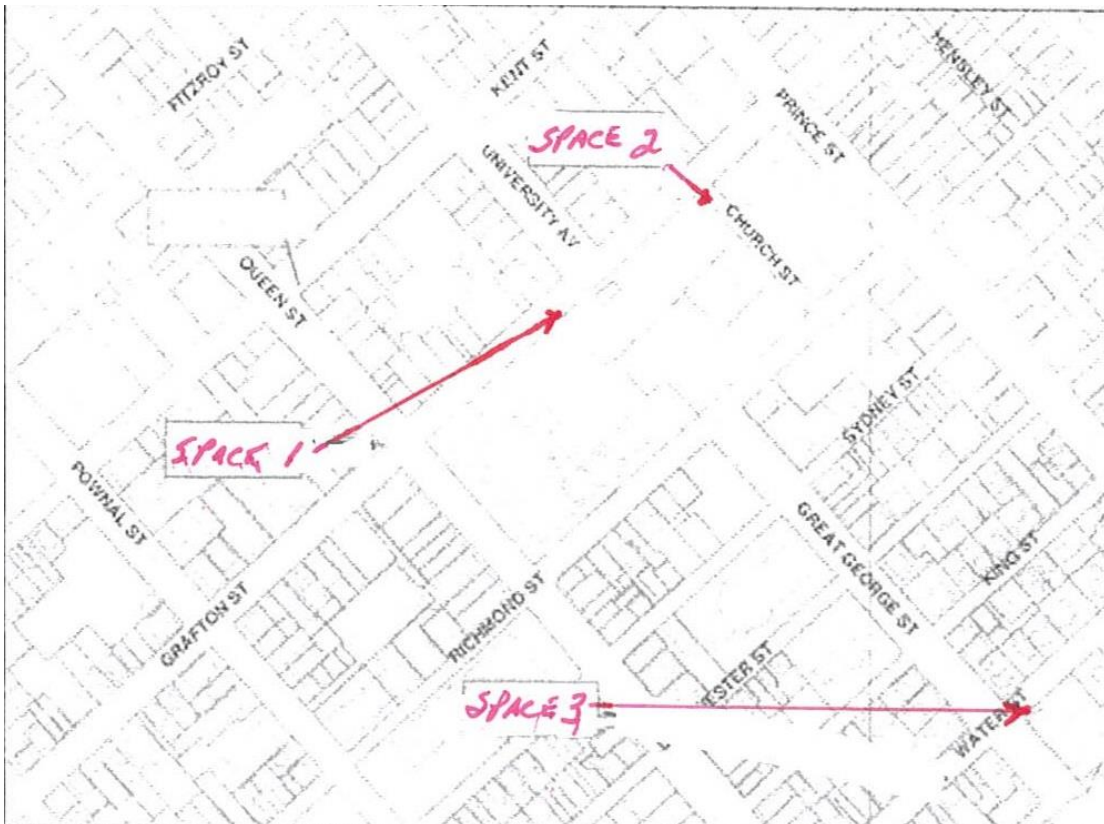

STREET VENDORS BYLAW

SCHEDULE “B” LICENSE FEE PER YEAR

- | | | |
|----|--|----------------------------|
| 1. | Push Cart per space | \$ 600.00 |
| 2. | Food Truck per space | \$1,200.00 (Apr-Dec) |
| 3. | Food Truck per space | \$1,600.00 (Year Round) |
| 4. | Street Vending per parking space | \$ 600.00 |
| 5. | Confectionary per tricycle | \$ 25.00 |
| 6. | Restaurant – Abutting Retailer or Lounge | \$600.00 per parking space |

STREET VENDORS BYLAW

SCCHEDULE "C" CHECK LIST

Push carts, food trucks and tricycles

1. Application
2. Full description and a photograph or an artist's concept of any confectionery tricycle, push cart or food truck.
3. Three (3) prints of a full faced photograph of applicant taken not more than 30 days prior to application.
4. Approvals:
 - (a) Police Service
 - (b) Building Inspector
 - (c) Fire Inspector
 - (d) Insurance for at least two million dollars (\$2,000,000) public liability with the City of Charlottetown named as third party and with notice given by the insurance company to the City of Charlottetown is the insurance is ever cancelled.
5. Confectionary Tricycles:
 - (a) Over 12 Under 16 Parental Consent
Employer Indemnity
6. Pedestrian Mall Owners:
 - (a) Mall agreement
7. Permits:
 - (a) Push Carts
 - (i) Public Health
 - Electrical
 - (b) Food Trucks
 - (i) Public Health
 - (c) Tricycles
 - (i) Public Health
8. Fee: Cash or certified cheque payable to the City of Charlottetown.

STREET VENDORS BYLAW



SCHEDULE "D"

STREET VENDORS BYLAW

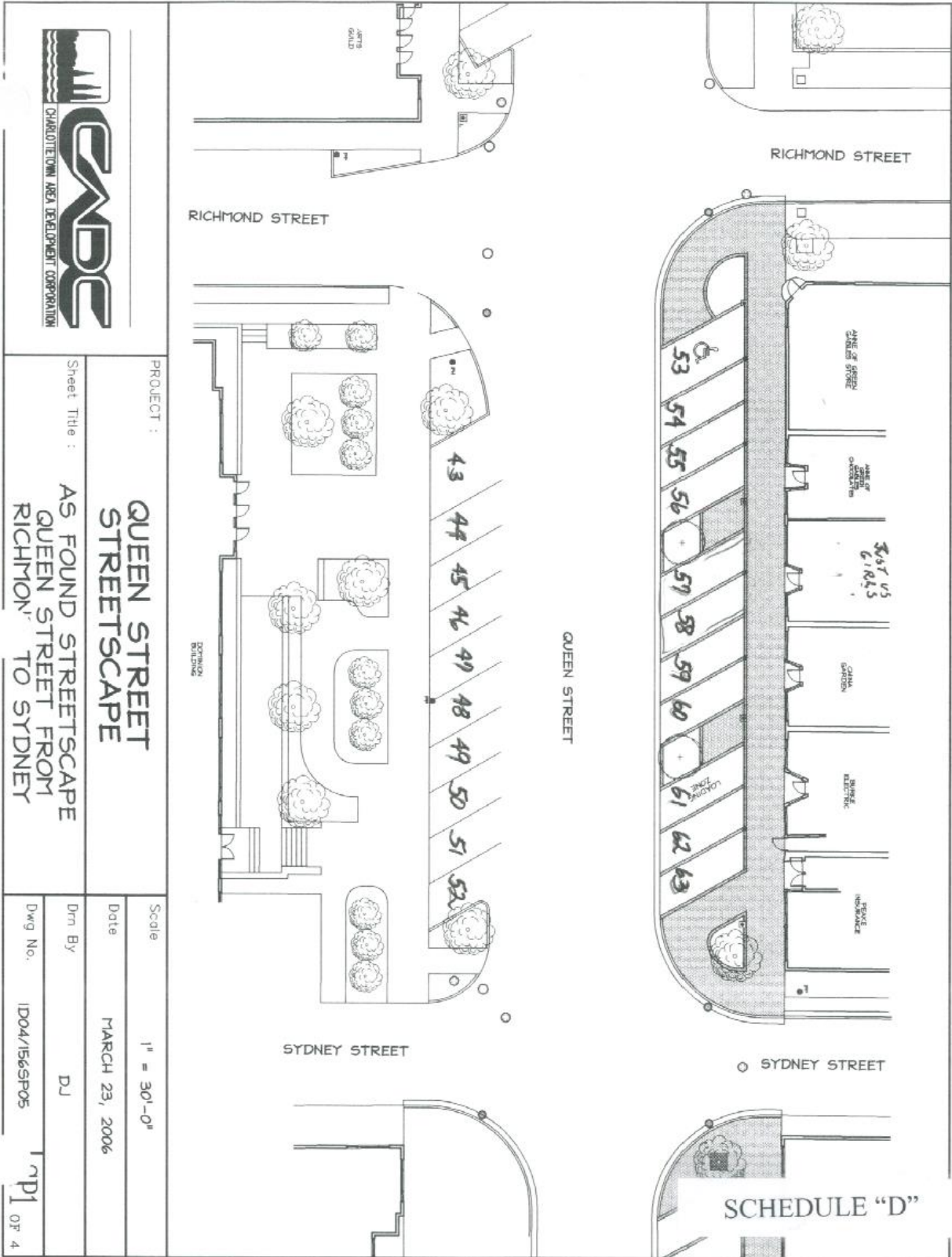

PROJECT :
**QUEEN STREET
STREETSCAPE**

Sheet Title :
**AS FOUND STREETSCAPE
QUEEN STREET FROM
RICHMOND TO SYDNEY**

Scale	1" = 30'-0"
Date	MARCH 23, 2006
Drn By	DJ
Dwg No.	1D04/156SP05

1 OF 4

STREET VENDORS BYLAW

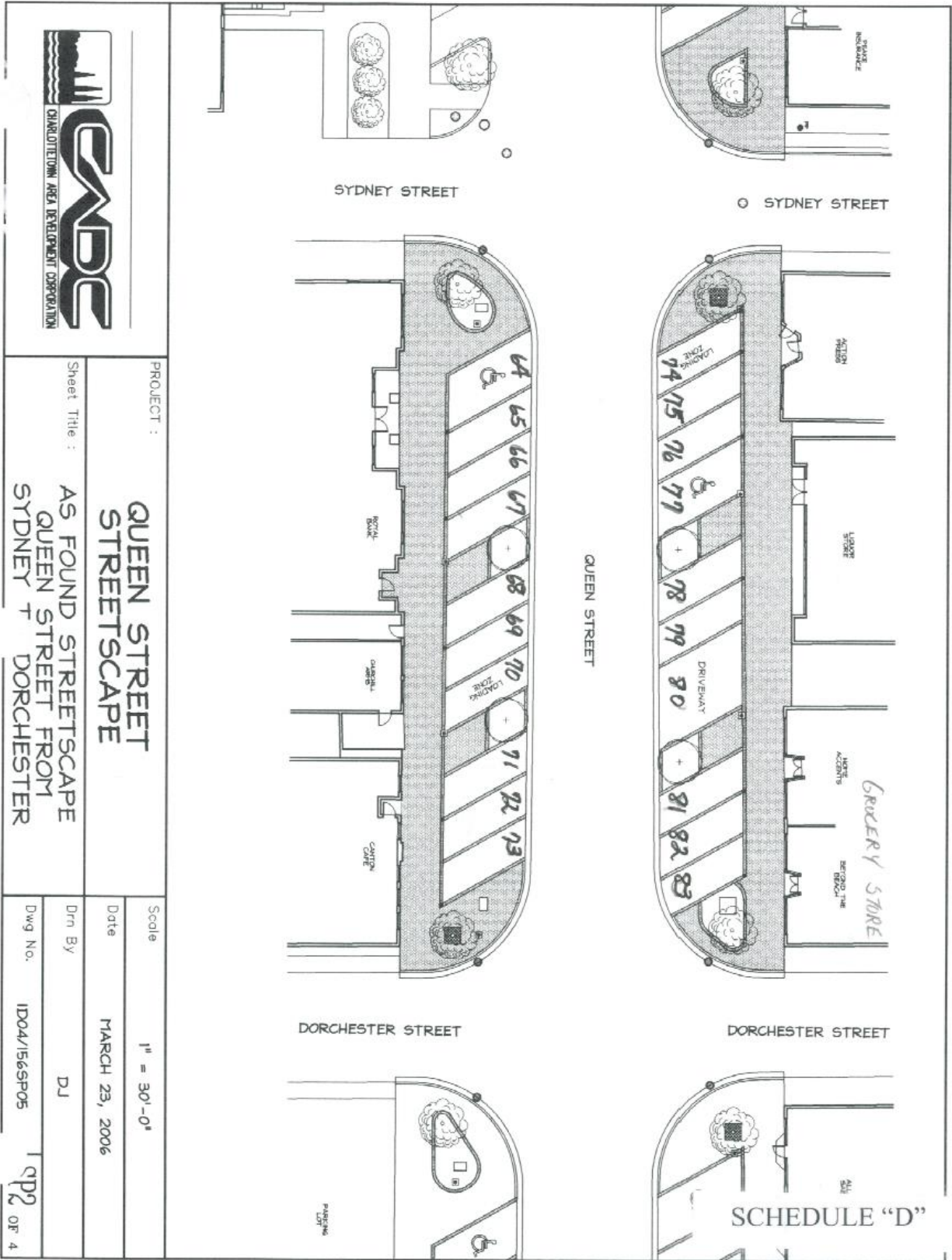

PROJECT :
**QUEEN STREET
STREETSCAPE**

Sheet Title :
**AS FOUND STREETSCAPE
QUEEN STREET FROM
SYDNEY TO DORCHESTER**

Scale : 1" = 30'-0"

Date : MARCH 23, 2006

Drn By : DJ

Dwg No. : ID04/1565F05

1 OF 4

STREET VENDORS BYLAW

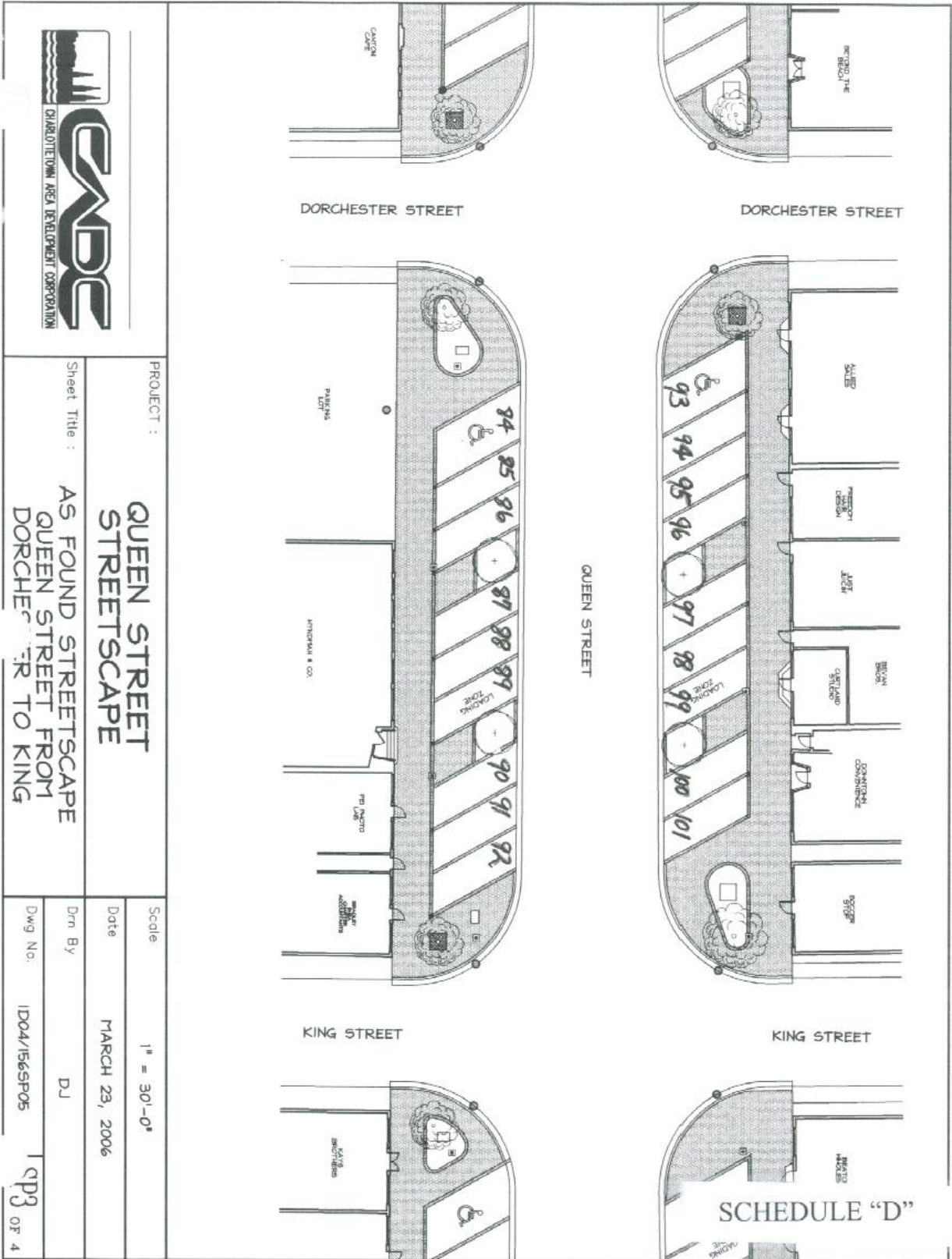

PROJECT :
**QUEEN STREET
 STREETSCAPE**

Sheet Title :
**AS FOUND STREETSCAPE
 QUEEN STREET FROM
 DORCHESTER STREET TO KING**

Scale 1" = 30'-0"

Date MARCH 23, 2006

Drawn By DJ

Dwg No. 1D04/156SP05

3 OF 4

STREET VENDORS BYLAW

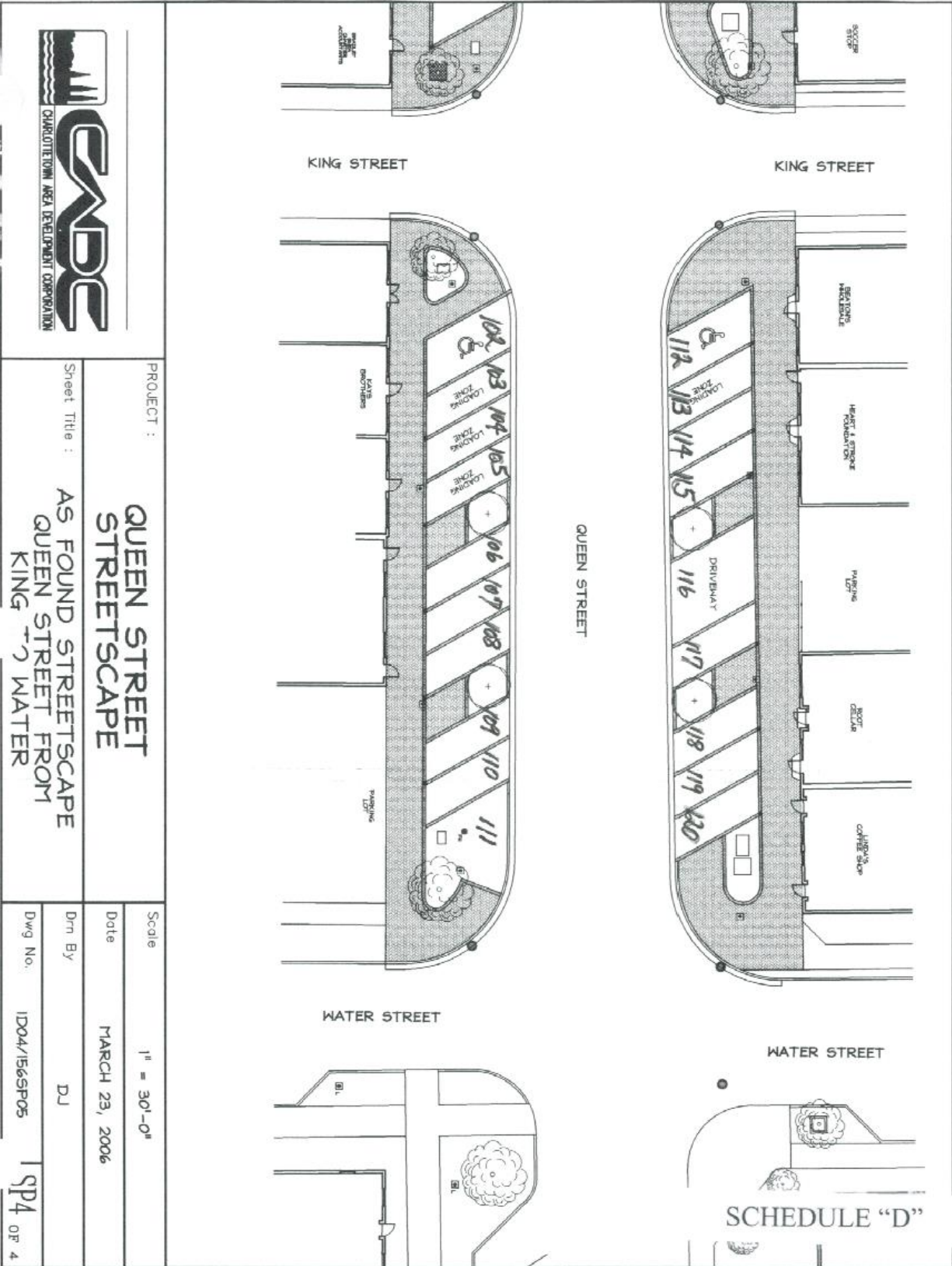

 <p>CHARLOTTE-TOWN AREA DEVELOPMENT CORPORATION</p>	PROJECT :	
	<p>QUEEN STREET STREETSCAPE</p>	
<p>Sheet Title :</p> <p>AS FOUND STREETSCAPE QUEEN STREET FROM KING TO WATER</p>	Scale	
	<p>1" = 30'-0"</p>	
Date		
<p>MARCH 23, 2006</p>		
Dwn By		
<p>DJ</p>		
Dwg No.		
<p>1D04/156SP05</p>		
SP4 OF 4		

STREET VENDORS BYLAW

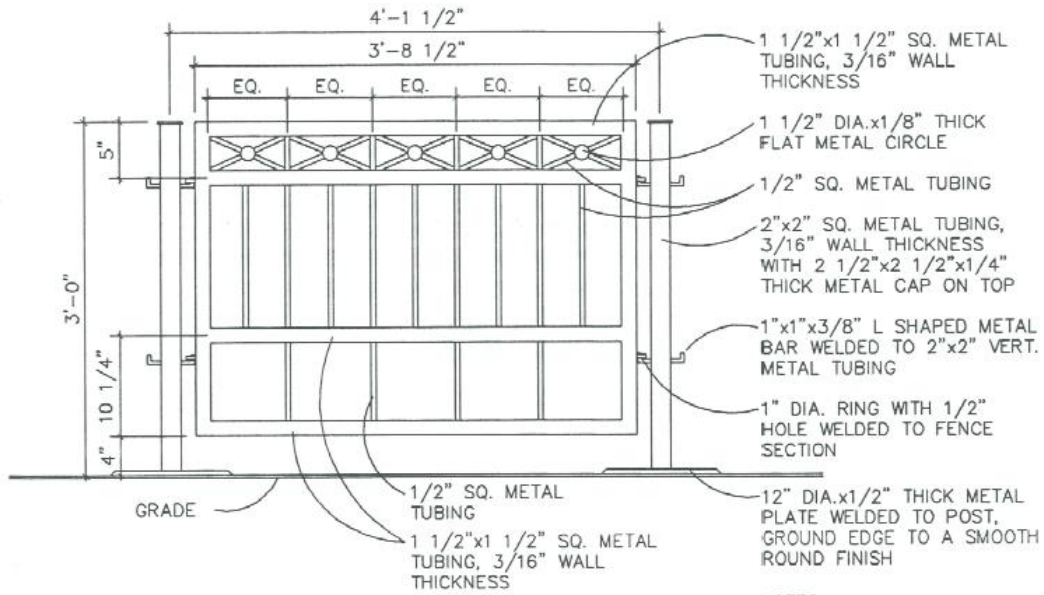

FENCE TYPE "1"
SCALE : 3/4" = 1'-0"

NOTES:

- ALL WELDS TO BE GROUND SMOOTH
- PRIME ALL WELDS
- SHOP PRIME AFTER FABRICATION
- PAINT WITH 2 COATS OF TREMCLAD FLAT BLACK OR EQUIVALENT

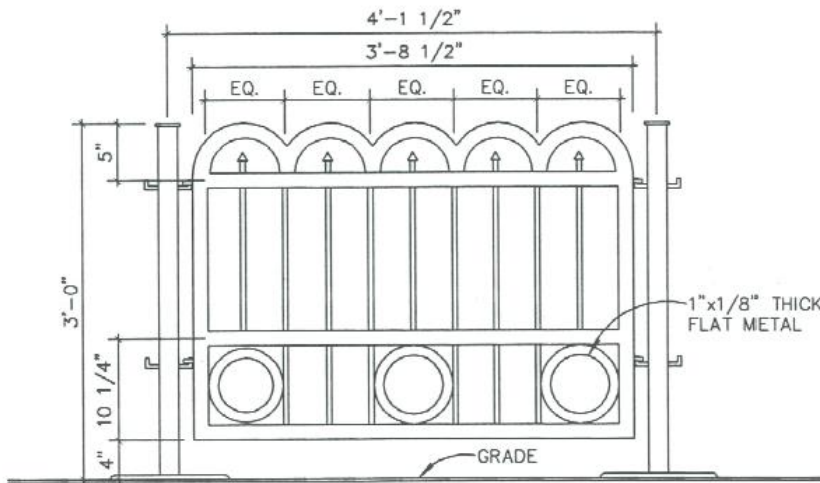

SEE FENCE TYPE "1" FOR TYPICAL FENCE CONSTRUCTION

FENCE TYPE "3"
SCALE : 3/4" = 1'-0"

SCHEDULE "D"

STREET VENDORS BYLAW

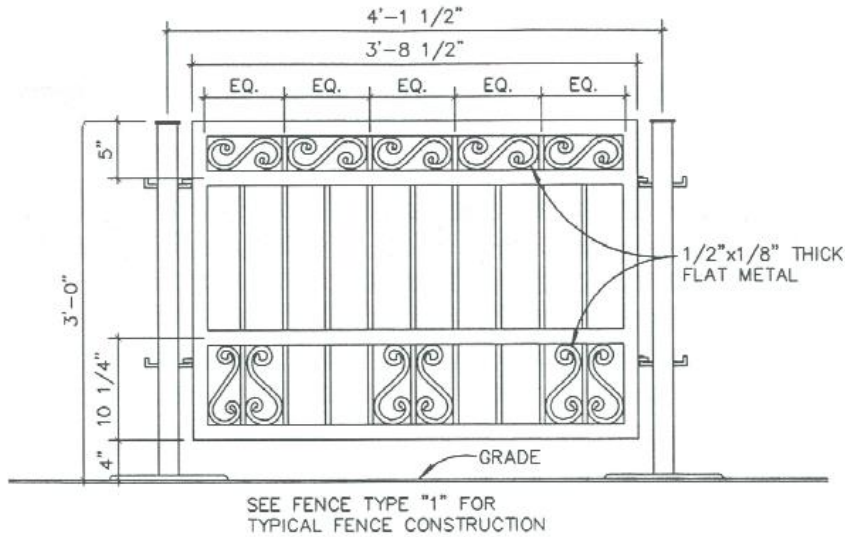

FENCE TYPE "2"
SCALE : 3/4" = 1'-0"

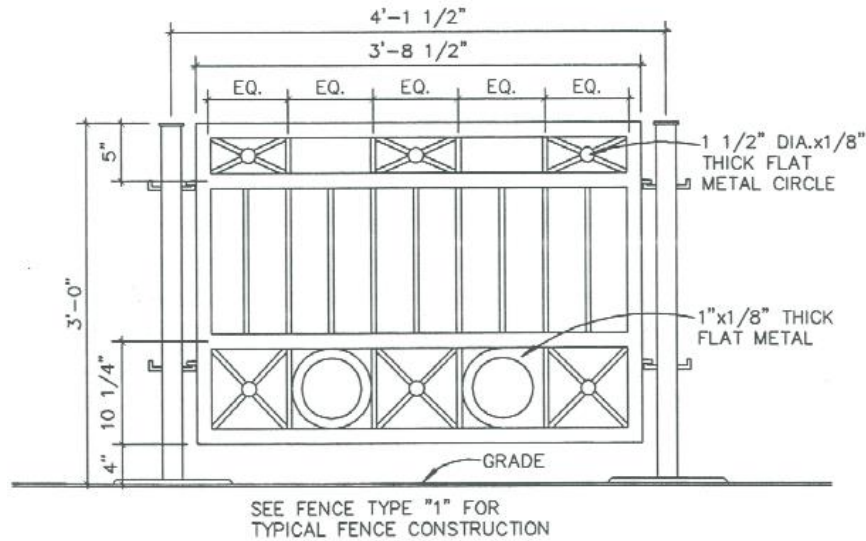

FENCE TYPE "4"
SCALE : 3/4" = 1'-0"

 <small>CHARLOTTE-TIMON AREA DEVELOPMENT CORPORATION</small>	
 ISLAND DRAFTING L.	
P.O. BOX 1701 Charlotte, P.E.I. C1 566-1600 FAX 568	
All measurements must be checked on the site by the co prior to construction or fabrication. This drawing is the property of Island Drafting Ltd. and sh be used on other projects or extensions to this project as writing from Island Drafting Ltd.	
Project :	
QUEEN STREET STREETScape	
Sheet Title :	
FENCE TYPES	
Scale	AS NOTED
Date	OCTOBER, 2004
Drn. BY	-
Dwg No.	ID04/156SP03
A OF	

SCHEDULE "D"

STREET VENDORS BYLAW

APPLICATION FOR STREET VENDORS LICENSE

The City of Charlottetown requires that all applicants read the Special Events Protocol and if alcohol service is being considered, the Events Alcohol Policy to ensure that their event meets all City requirements.

Business Name:

Is this a first time application? Yes <input type="checkbox"/> No <input type="checkbox"/>	Number of years in business?
Type of Vendors License: <input type="checkbox"/> Confectionary Tricycle <input type="checkbox"/> Food Truck <input type="checkbox"/> Push Cart	

Applicant:	
Mailing Address & Postal Code:	
Telephone #(day):	Telephone #(night):
Cell:	Fax:
Email Address:	

Description of Goods Being Offered for Sale:

Location(s) Requested:	
Food Truck – Location 1 <input type="checkbox"/> Location 2 <input type="checkbox"/> Location 3 <input type="checkbox"/> Push Cart – Location 1 <input type="checkbox"/> Location 2 <input type="checkbox"/> Location 3 <input type="checkbox"/> Confectionary Tricycle – Residential Area Only	
Start Date: Seasonal - Apr to Dec <input type="checkbox"/> Year Round (Food Trucks Only) <input type="checkbox"/>	End Date:
Operating Hours - Start:	Operating Hours - Closing:

STREET VENDORS BYLAW

Apparatus Description Information: (Confectionary/Food Truck/Push Cart Licenses Only)

Make:	Model:	Year:
Serial Number:		
Does Vehicle/Equipment require Provincial Vehicle Registration?:		
Yes <input type="checkbox"/> No <input type="checkbox"/>		
License Number:		Inspection Valid Until:

EMPLOYEE INFORMATION (Confectionary/Food Truck/Push Cart Licenses Only)

Employees Name:	
Mailing Address & Postal Code:	
Telephone #(day):	Telephone #(night):
Cell:	Date of Birth:
Employees Name:	
Mailing Address & Postal Code:	
Telephone #(day):	Telephone #(night):
Cell:	Date of Birth:

ATTACHMENTS - Check all that apply:

Photographs/Artist Conception of: Confectionary Tricycle <input type="checkbox"/> Food Truck <input type="checkbox"/> Push Cart <input type="checkbox"/>		
Site Plan of Selected Location:	Attached <input type="checkbox"/>	
Certificate of Insurance	Attached <input type="checkbox"/>	
Hold Harmless Agreement	Attached <input type="checkbox"/>	
Photos (3) Applicant	Attached <input type="checkbox"/>	
Photos Employee(s)	Attached <input type="checkbox"/>	
Pedestrian Mall Agreement	Attached <input type="checkbox"/>	Not Required <input type="checkbox"/>
Public Health Certificate	Attached <input type="checkbox"/>	Not Required <input type="checkbox"/>
Electrical Inspection Certification	Attached <input type="checkbox"/>	Not Required <input type="checkbox"/>

STREET VENDORS BYLAW

The applicant acknowledges that he/she has read the Street Vendors Bylaw in its entirety, fully understands the terms and conditions as outlined and has fully disclosed all details and components related to applications of the street vending license.

Applicant Name:	Date:
Applicant Signature:	

HOLD HARMLESS AGREEMENT

_____ (Name of Applicant) shall indemnify and hold the City of Charlottetown and the Charlottetown Police Services harmless from and against all liability, loss, claims, demands, costs, and expenses, including reasonable legal fees, occasioned wholly or in part by any negligence or acts or omissions by the above named, their officers, agents, employees, or others for whom they are responsible at law arising out of any cause whatsoever, either direct or indirect, through its use and/or operation of City property in connection with

(Street Vending Business)

excluding only such liability as may solely rise out of the negligence of the City and/or Police Services, its employees, officers, or agents.

STREET VENDORS BYLAW

INSURANCE CERTIFICATE

During the period of the term of this license agreement with,

(Street Vending Business & Applicant)

shall maintain a policy of public liability and property damage insurance, including liquor liability coverage if applicable, in the amount of Two Million Dollars (\$2,000,000) and containing endorsements showing “The Corporation of the City of Charlottetown” as an additional insured and having a cross-liability clause, in form satisfactory to the City of Charlottetown. Proof of insurance shall be made available to the City of Charlottetown with this application.

Name of Applicant – must be incorporated or an individual:	
Signature of Applicant or Authorized Representative:	Signature of Witness:
Print Name and Title:	Print Name of Witness:
Date	

STREET VENDORS BYLAW

EMPLOYER INDEMNITY

CONFECTIONARY TRICYCLE USE ONLY:

I, _____ hereby covenant, undertake and agree to accept full responsibility for _____ an employee of mine and to save harmless and keep indemnified the said City of Charlottetown, the employee _____ and his parents or guardians from and against all claims and demands whatsoever in respect of his employment in regards to finances and negligence.

Applicant Name:	Date:
Applicant Signature:	
Name of Witness	Signature of Witness:

STREET VENDORS BYLAW

PARENTAL CONSENT

CONFECTIONARY TRICYCLE USE ONLY:

We/I the undersigned being the parents or parent of _____,
an employee of _____ acknowledge that _____
is of the age of _____ and that he may be employed as a confectionery tricycle vendor.

Parent(s) Name:	Date:
Parent(s) Signature:	
Name of Witness	Signature of Witness:

STREET VENDORS BYLAW

Amendment Summary	Previous Wording	Amendment Detail	1st Reading	2nd Reading	3rd Reading
Amend various sections	(p) " <u>push cart</u> " means a hand-operated vehicle used or intended to be used for displaying, storing, transporting goods and from which goods may be sold;	Amend the definition of "push cart" under (p) as follows: (p) "push cart" means a hand-operated vehicle or display devise used or intended to be used for transporting, storing, displaying and selling of goods. The display devise or hand operated vehicle may be towed to the site but it must be small enough to be movable off the site by hand, by the licensed operator;	14-Jun-95	21-Jun-95	21-Jun-95
	<i>nothing</i>	Amend 4(a) by adding (vi) as follows: 4(a)(vi) A person selling for charitable organizations or non-profit groups such as but not limited to school activities, girl guides, boy scouts, etc.			
	4(b)(iv) A flower vendor may carry on business pursuant to a flower vendor's license issued pursuant to this Bylaw and within the areas designated in subsection 5(e); and	Amend 4(b)(iv) by changing in the last sentence "Subsection 5(c)" to "Subsection 5(d)"			
	5(c)(i) from the space in the pedestrian mall allotted to him by the Licensing Inspector under this Bylaw; or (ii) from the space in the designated push cart areas allotted to him by the Licensing Inspector under this Bylaw as approved by resolution of City Council	Delete Section 5(c)(i) and change Section "5(c)(ii)" to "5(c)(i)" with the following changes: 5(c)(i) from the space in the designated push cart areas allotted to him by the Licensing Inspector under Schedule "B" of the Bylaw.			
	6(c)(i) use only a push cart specified in a license issued to him and for which a license plate has been issued under this Bylaw;	Section 6(c)(i) - Delete the words "and for which a licence plate has been issued"			
	6(c)(ii) fasten the license plate issued under this Bylaw in a conspicuous place on the push cart;	Section 6(c)(ii) - Delete this section and renumber the sections following it accordingly.			
	6(c)(xiv) if located elsewhere than on the pedestrian mall, not sell or otherwise dispose of any goods elsewhere than on the curbside of the push cart or on the side of the push cart nearest the boundary of the street if there is no sidewalk;	Old Section # 6(c)(xiv) - Delete the words "if located elsewhere than on the Pedestrian Mall"			
	7(c)(vi) where applicable, the location in the pedestrian mall or in the designated push cart areas in which the applicant would prefer to carry on business;	Section 7(c)(vi) - Delete the words "where applicable the location in the pedestrian mall or in"			

STREET VENDORS BYLAW

Amendment Summary	Previous Wording	Amendment Detail	1st Reading	2nd Reading	3rd Reading
	<p>7(d) All applications for license after January 1, 1987 to carry on business from a push cart shall be submitted to the Licensing Inspector between January 1st in each year and no later than March 31st in any year or until all sites are selected. All other applications for license under this Bylaw must be submitted to the Licensing Inspector no later than June 1st in any year.</p> <p>(i) The City shall advertise in February that all applications must be submitted by March 31st in each year.</p>	<p>Amend Section 7(d) as follows: 7(d) All applications for licenses shall be made after January 1, of each year to carry on a business under this bylaw Delete Section 7(d)(i)</p>			
	<p>7(e)(vii) a certificate of insurance in respect of such insurance policy in a form satisfactory to the City Solicitor providing that such insurance policy cannot be cancelled or terminated without the City being given what is in the opinion of the City Solicitor sufficient prior notice has been provided to the Licensing Inspector;</p>	<p>Section 7(e)(vii) - Delete the following words "in a form satisfactory to the City Solicitor" and "the City being given what is in the opinion of the City Solicitor"</p>			
	<p>7(e)(x) an applicant to whom a license to sell goods from a push cart in the pedestrian mall has entered into an agreement in writing with the City under which he has agreed to be open for business in the year for which the license has been issued from 8:00 o'clock a.m. to 10:00 o'clock p.m. each day from Monday to Saturday in each week from June 15th to September 15th inclusive.</p>	<p>Delete Section 7(e)(x)</p>			
	<p>8.(a) If, in any year, the Licensing Inspector receives more applications form push cart vendors than there are spaces established for push carts in the pedestrian mall and in designated push cart areas, then the Licensing Inspector</p>	<p>Amend Section 8(a) - near the beginning of the 1st sentence delete the words "in the pedestrian mall and". Near the end of the 1st sentence delete the words "and who in" & replace with "with students returning to school to be given the highest priority and then in the order of the date of receipt of applications. The Licensing Inspector may also consider the following standards:"</p>			

STREET VENDORS BYLAW

Amendment Summary	Previous Wording	Amendment Detail	1st Reading	2nd Reading	3rd Reading
	<p>shall issue only as many licenses as there are such spaces to those applicants who have complied with all the applicable requirements of this Bylaw for the issuance of the license sought and who, in the Licensing Inspector's opinion, best meet the following standards:</p> <ul style="list-style-type: none"> (i) quality in the workmanship and materials used in the construction of the push cart; (ii) attractiveness in the design and colouration of the push cart; (iii) quality in the goods intended to be sold; (iv) uniqueness in the goods intended to be sold; and (v) in order of date of receipt of application. <p>9.(a) An abutting retailer may make application to the Licensing Inspector for a permit to conduct a sidewalk sale of goods other than food products. An application for such a permit shall be on a form prescribed by the Licensing Inspector and contain:</p>	<p>Sections (i), (ii), (iii) & (iv) to remain the same. Delete Section (v)</p> <hr/> <p>Section 9(a) - in the first sentence delete "other than" and insert "beverage and"</p>			

STREET VENDORS BYLAW

Amendment Summary	Previous Wording	Amendment Detail	1st Reading	2nd Reading	3rd Reading
	<p>9.(b) No permit shall be issued to an abutting retailer under this Section unless:</p> <p>(i) the applicant is seeking a permit to hold a sidewalk sale on a sidewalk abutting his permanent place of business;</p> <p>(ii) the occupation of the sidewalk proposed by the applicant will not impede pedestrian traffic or block or impair the entrance to any premises abutting the area proposed to be occupied by the applicant during the sidewalk sale; and</p> <p>(iii) the size and proposed location of all tables or racks or other display devices intended to be used by the applicant during the sidewalk sale has been approved by the Licensing Inspector.</p> <p>(c) A permit issued under this Bylaw to an abutting retailer shall permit him to hold a sidewalk sale of goods described in the permit on that portion of the sidewalk specified in the permit.</p> <p>(d) An abutting retailer who has been issued a permit under this Section shall be subject to and shall comply with the provisions of Subsections 6(c)(iv), 6(c)(v), 6(c)(vii), 6(c)(ix), 6(c)(x), 6(c)(xii),</p>	<p>Delete Section 9(b) to (e) and replace with the following sections as follows:</p> <p>9.(b)(i) The Downtown Business Association of the Chamber of Commerce may make application to the Licensing Inspector to hold sidewalk sales for the months of June, July, August and September as long as Section 7(a), (b), (c), (d) and (e) have been complied with.</p> <p>(ii) A list of abutting retailers who wish to operate a sidewalk sale shall be submitted to the City showing addresses and telephone number of the merchants.</p> <p>(c) The Planning Board shall make a decision on which day(s) of the week all retailers may hold sidewalk sales without requiring permits but there shall be no more than two days designated for sidewalk sales in one week.</p> <p>(d) Special requests for sidewalk sales other than the day(s) designated shall be made to the Licensing Inspector and Council may approve the special requests.</p> <p>(e) If requested by the Licensing Inspector provide the size and proposed location of any tables, racks or other display devices to be used by</p>			
	<p><i>nothing</i></p>	<p>Add New section (f) as follows: (f)Such other information as the Licensing Inspector may require.</p>			

STREET VENDORS BYLAW

Amendment Summary	Previous Wording	Amendment Detail	1st Reading	2nd Reading	3rd Reading
	<i>nothing</i>	<p>Add New section (g) as follows:</p> <p>(g) A permit shall be issued under this Bylaw to an abutting restaurant or lounge and shall permit them to hold a sidewalk sale of food and beverages with a dining-room licence only, under the Liquor Control Act of the Province (R.S.P.E.I. 1974, Caps. 2-17) provided;</p> <p>(1) the provisions of Section 9(a), (b), (c), (d), (e) & (f) are followed.</p> <p>(2) Council have approved the use of any areas between the sidewalk and the street</p> <p>(3) Council have approved the closing of part or all of the travel portion of the sidewalk for a specified time.</p> <p>(4) That sidewalk sales for a licensed restaurant or lounge be permitted in those areas of the City south of Fitzroy Street.</p> <p>(5) Council shall require that an agreement be signed with the City, and Council shall consider but is not limited to the following in the agreement:</p> <p>(a) Liability Insurance</p> <p>(b) Time limits for use of the street right-of-way</p> <p>(c) Any fees to be charged for encroachment on a street right-of-way</p> <p>(d) A scaled drawing showing the</p>			
Amend section 6.3 (d): change from 2:00 a.m. to 2:30 a.m.	6.3(c) not vend between 2:00 a.m. and 10:00 a.m. on any day;	Amend section 6.3 (c) as follows: 6.3 (c) not vend between 2:30 a.m. and 10:00 a.m. on any day;	13-May-96	13-May-96	23-May-96
Amend section 8.4: change in season, amend Schedule B, and C, and applicable forms	8.4 The license issued under this Bylaw shall be deemed to be in force from the 1st day of May in any year to the 31st day of October in the same year.	Amend section 8.4: change season date from "the 1 st of May in any year to the 31 st day of October in the same year" to " the 1st day of April in any year to the 1st day in December in the same year "	14-Apr-98	14-Apr-98	23-Apr-98
	Schedule "B" - DESIGNATED PUSH CART AREA - STREET VENDORS - SITES 3. South west corner of Grafton and Church Streets east of Meter #28. 5. North west corner of Kent and Pownal Streets - Meter space #9. 7. Longworth Avenue, Euston and Weymouth Streets - corner	Amend Schedule "B": delete numbers 3, 5 and 7, and renumber to proper sequence.			
	Fee: Push Cart \$500.	Amend Schedule "C": amend push cart fee from "\$500." to " \$600. "			

STREET VENDORS BYLAW

Amendment Summary	Previous Wording	Amendment Detail	1st Reading	2nd Reading	3rd Reading
	Intended Time of Operation: Seasonal: (June 15th - Sept. 15th) push cart fee \$500	Amend Form: Intended Time of Operation: Seasonal: (April 1 - December 1) and change push cart fee to \$600 to correspond with Schedule "C"			
An amendment to the Street Vendors Bylaw to allow street vendors to sell food items only	2.6 " Designated Mobile Canteen Areas " means those areas within the City designated in Schedule "A" of this Bylaw as areas in which the selling of food products from a mobile canteen is permitted;	Section 2.6 - Remove definition of " Designated Mobile Canteen Areas "	9-Dec-02	9-Dec-02	13-Jan-03
	2.7 " Designated Push Cart Areas " means those areas within the City designated in Schedule "B" of this Bylaw as areas in which the selling of goods from a push cart is permitted;	Section 2.7 " Designated Push Cart Areas " Replace the words 'Schedule "B"' with 'Schedule "A"'. Replace the word 'goods' with 'food products'			
	2.12 " Mobile Canteen " means any motor vehicle registered pursuant to the <u>Highway Traffic Act R.S.P.E.I. 1974</u> , Cap. H-6 used or intended to be used for displaying, storing or transporting food products and from which food products may be sold;	Section 2.12 - Remove definition of " Mobile Canteen "			
	2.13 " Mobile Canteen Vendor " means any person who owns and operates or has operated for him a mobile canteen from which food products may be sold;	Section 2.13 - Remove definition of " Mobile Canteen Vendor "			
	4.2 Notwithstanding Sections 3, Subsection 3.1 and 3.2 of this Bylaw: (b) A mobile canteen vendor who has been issued a license under this Bylaw may carry on business in the areas designated in Subsection 5.2 of this Bylaw;	Remove Section 4.2 (b)			

STREET VENDORS BYLAW

Amendment Summary	Previous Wording	Amendment Detail	1st Reading	2nd Reading	3rd Reading
	<p>5.2 A mobile canteen vendor who has been issued a license under this Bylaw may sell food products from a mobile canteen for which a license plate has been issued under this Bylaw in the following areas within the City but within no others:</p> <p>(a) On construction sites; and</p> <p>(b) In the designated mobile canteen areas.</p>	Remove Section 5.2			
	5.3 (a) from the space in the designated push cart areas allotted to him by the Licensing Inspector under Schedule "B" of the by-law.	Section 5.3 (a) Replace the words 'Schedule "B"' with 'Schedule "A"'			
	5.5 Notwithstanding Subsection 5.2 and any other provision of this Bylaw, no more than one mobile canteen shall be parked or placed in either Victoria Park or in Queen Elizabeth Park for the purposes of selling food products therefrom at any one time.	Remove Section 5.5			
	<p>6.2 A mobile canteen vendor who has been issued a license under this Bylaw shall:</p> <p>(a) use only a motor vehicle specified in a license issued to him and for which a license plate has been issued under this Bylaw;</p> <p>(b) fasten the license plate issued under this Bylaw in a conspicuous place on the mobile canteen;</p> <p>(c) maintain the mobile canteen in good repair and appearance;</p> <p>(d) equip the mobile canteen with a refuse container;</p> <p>(e) use no loud speakers or amplifiers or other hailing devices;</p>	Remove Section 6.2			

STREET VENDORS BYLAW

Amendment Summary	Previous Wording	Amendment Detail	1st Reading	2nd Reading	3rd Reading
	<p>(f) comply with all provincial and municipal health standards for the mobile canteen and the manner of storing and handling the food products sold therefrom;</p> <p>(g) sell only food products;</p> <p>(h) not carry on business other than in those areas within the City designated in Subsection 5.2 of this Bylaw; and</p> <p>(i) maintain any insurance required under this Bylaw in full force and effect during the currency of any license issued to him hereunder.</p>				
	<p>7.2 An applicant for a license under this Bylaw shall make a separate written application to the Licensing Inspector for each confectionery tricycle, mobile canteen, or push cart, as the case may be, which he intends to operate or which he intends to have operated for him.</p>	<p>Section 7.2 Remove the words 'mobile canteen'.</p>			
	<p>7.5 (a) the license fee prescribed in Schedule "C" to this Bylaw has been paid;</p>	<p>Section 7.5 (a) Replace the words 'Schedule "C"' with 'Schedule "B"'. .</p>			
	<p>7.5 (e) a certified copy of a public liability insurance policy in a form and in an amount established and described in Schedule "D" annexed hereto which has been approved by resolution", naming the City as an additional named insured has been provided to the Licensing Inspector;</p>	<p>Section 7.5 (e) Replace the words 'Schedule "D"' with 'Schedule "C"'. .</p>			
	<p>7.7 A license to sell goods from a push cart issued in accordance with this Bylaw shall only permit the holder thereof to operate from a location specified on that license the push cart identified in that license for the display and sale of the goods described in that license.</p>	<p>Section 7.7 Replace the word 'goods' with 'food'. .</p>			

STREET VENDORS BYLAW

Amendment Summary	Previous Wording	Amendment Detail	1st Reading	2nd Reading	3rd Reading
	<i>nothing</i>	<p>Section 8.1 – prior to subsection (a), new wording to include: For the issuance of licenses, the following shall apply: Subsequent to March 01 and prior to March 15 of any year, applications complying with this Bylaw received on or prior to March 01 shall be reviewed and consideration of issuance of licenses shall be on the following basis: (a) firstly, to students who have indicated that they are planning to return to school in the fall; (b) then to local Charlottetown businesses; (c) then to all other applicants. (d) consideration of licenses received after March 15 of any year shall be on an as received basis or the above criteria may apply.</p>			
	<p>12.3 Where a person is carrying on a business in contravention of this Bylaw, where a breach of this Bylaw is of a continuing nature, or where a person is carrying on business without a license required under this Bylaw, then in addition to any other remedy or penalty imposed by this Bylaw the City may, in all such cases, apply to the Supreme Court of Prince Edward Island for an injunction or other order prohibiting or restraining that person from contravening this Bylaw.</p>	<p>Section 12.3 Remove the words 'where a breach of this Bylaw is of a continuing nature, or where a person is carrying on business without a license required under this Bylaw'</p>			
	<p>13.4 In the year 1987 additional applications for push car licenses will be accepted after March 31, 1987.</p>	<p>Remove Section 13.4</p>			
	<p>SCHEDULE "A" – DESIGNATED MOBILE CANTEEN AREA 1. Queen Elizabeth Co-op Park 2. Victoria Park – Between the City Diamond and the Little League Diamond Only one mobile canteen shall be permissible in Victoria Park and only one mobile canteen shall be permissible in the Queen Elizabeth Co-op Park. By a resolution of Council the number may be increased for special events if recommended by the Recreation Comm.</p>	<p>Remove SCHEDULE "A"</p>			

STREET VENDORS BYLAW

Amendment Summary	Previous Wording	Amendment Detail	1st Reading	2nd Reading	3rd Reading
	<p>SCHEDULE "C" CHECKLIST Push carts, mobile canteens and tricycles 2. Full description and a photograph or an artist's concept of any confectionery tricycle, mobile canteen, or push cart. 4.(d) Insurance satisfactory to solicitor for at least one million dollars (\$1,000,000.00) public liability. 7. Permits: (a) Mobiles (i) Public Health (ii) Vehicle Registration</p> <p>APPLICATION FOR STREET VENDORS LICENSE PREFERRED AREA OF BUSINESS: MARK AN "X" AND SPECIFY (d) MOBILE CANTEEN</p> <p>PHOTOGRAPHS OR ARTIST CONCEPT ATTACHED (AS PER BYLAW) OF CONFECTIONERY TRICYCLE, MOBILE CANTEEN OR PUSH CART. THREE (3) PHOTOGRAPHS OF THE APPLICANT ATTACHED (AS PER BYLAW).</p> <p>Last page – INTENDED HOURS OF OPERATION: 8 a.m. - 10 p.m. _____ DAYLIGHT HOURS 8 a.m. - 5 p.m. ____</p> <p>FEE: MARK X <u>ALL ARTICLES CONFECTIONERY</u> PUSH CART \$600.00 _ \$25.00 _____ MOBILE CANTEEN \$800.00 Seasonal _____ \$1,000.00 Yearly _____</p>	<p>SCHEDULE "C" CHECKLIST – From the 1st sentence - remove the words 'mobile canteens'. From item #2 - remove the words 'mobile canteen'. From item #4(d) - remove the words 'satisfactory to solicitor'. From item #4(d) - at the end, new wording to include 'with the City of Charlottetown named as third party and with notice given by the insurance company to the City of Charlottetown if the insurance is ever cancelled.' From item #7 - remove part (a) Mobiles.</p> <p>APPLICATION FOR STREET VENDORS LICENSE – Under the area of 'PREFERRED AREA OF BUSINESS' – Remove part (d) MOBILE CANTEEN.</p> <p>Remove the words 'MOBILE CANTEEN' from last paragraph at end of application.</p> <p>INTENDED HOURS OF OPERATION: Replace the time '8 a.m.' with '10 a.m.' in both areas of that line. Under the area of 'FEE', remove the "MOBILE CANTEEN" option.</p>			

STREET VENDORS BYLAW

Amendment Summary	Previous Wording	Amendment Detail	1st Reading	2nd Reading	3rd Reading
<p>To remove reference of “mobile canteens” in Sec 7.3(c) and 8.9 (as per Jan 2003 amendment); to define a minimum fine of \$100 and a maximum fine of \$500 for offence infractions to be reflective of similar penalties in other provincial and municipal legislation; to include an enforcement provision for daily infractions.</p>	<p>7.3(c) a full description, and a photograph or an artist's concept, of any confectionery tricycle, mobile canteen, or push cart, for which a license plate is sought together with the serial and registration number, if any, of the vehicle;</p>	<p>Section 7.3(c) Remove the word 'mobile canteen'.</p>	<p>12-Jul-04</p>	<p>12-Jul-04</p>	<p>14-Jul-04</p>
	<p>8.9 A police officer, the License Inspector or any other person authorized by Council may inspect any confectionery tricycle, mobile canteen or push cart for which a license plate has been issued under this Bylaw at all reasonable times.</p>	<p>Section 8.9 Remove the word 'mobile canteen'.</p>			
	<p>12.1 A person who violates or fails to comply with the provisions of this Bylaw is guilty of an offence and is liable on summary conviction to a fine not exceeding \$500.00 and in default of payment to imprisonment for a period not exceeding 30 days.</p>	<p>12.1 A person who violates or fails to comply with the provisions of this Bylaw is guilty of an offence and is liable on summary conviction to a fine of not less than \$100 and not more than \$500 and in default of payment to imprisonment for a period not exceeding 30 days.</p>			
	<p>12.2 Where a person is carrying on business without a license required by this Bylaw, or from a space other than the space allocated to him and specified in a license issued under this Bylaw, in addition to any other remedy or penalty imposed by this Bylaw, the City may immediately and without notice of any kind remove any vehicle or other device used in the storing, transporting, displaying or selling of goods together with any goods displayed thereon to a place selected by the City and all costs and charges incurred by the City for the removal and storage shall be a lien</p>	<p>12.2(a) Where a person is carrying on business without a license required by this Bylaw, or from a space other than the space allocated to him and specified in a license issued under this Bylaw, in addition to any other remedy or penalty imposed by this Bylaw, the City may immediately and without notice of any kind remove any vehicle or other device used in the storing, transporting, displaying or selling of goods together with any goods displayed thereon to a place selected by the City and all costs and charges incurred by the City for the removal and storage shall be a lien thereon and the City may, by action in any Court of competent jurisdiction, recover as a civil debt due to the City by the owner the cost of removal and storage thereof; and (b) Each day a person so operates shall comprise a separate offence.</p>			

STREET VENDORS BYLAW

Amendment Summary	Previous Wording	Amendment Detail	1st Reading	2nd Reading	3rd Reading
	thereon and the City may, by action in any Court of competent jurisdiction, recover as a civil debt due to the City by the owner the cost of removal and storage thereof.				
<p>To amend the Street Vending Bylaw:</p> <ul style="list-style-type: none"> to allow for the sale of food, grocery and beverage products in designated parking spaces on Queen Street south of Grafton Street; and to add wording clarity to various sections throughout. 	<p>2.1 "Abutting Retailer" means a person who carries on retail business from a permanent place of business abutting a sidewalk in the City and who pays business taxes to the City;</p>	<p>Amend as follows: 2.1 "Abutting Retailer" means a person who carries on retail business from a permanent place of business abutting a sidewalk in the City and pays business taxes to the City or is a tenant of the building for which taxes are paid to the City;</p>	10-May-06	10-May-06	11-May-06
	<p><i>Nothing</i></p>	<p>Add new definition: 2.2 "Agreement" means all agreements mentioned in this Bylaw which shall be executed by the Mayor and Chief Administrative Officer of the City of Charlottetown;</p>			
	<p><i>Nothing</i></p>	<p>Add the words "and/or beverages" after the word 'food' in Sections 2.6, 2.9, 2.10, 2.11, 2.13, 2.14, 7.7</p>			
	<p>4.1(c) A person using a portion of a street for a reasonable time during the taking in or delivery of goods;</p>	<p>Section 4.1(c) Remove subsection and renumber remaining subsections</p>			
	<p>4.2 Notwithstanding Sections 3, Subsection 3.1 and 3.2 of this Bylaw:</p>	<p>Section 4.2 Remove the words "Sections 3"</p>			
	<p>8.1(d) Consideration of licenses received after March 15 of any year shall be on an as-received basis or the above criteria may apply.</p>	<p>Amend as follows: 8.1(d) Consideration of licenses received after March 15 of any year shall be on an as-received basis and the above criteria may apply.</p>			

STREET VENDORS BYLAW

Amendment Summary	Previous Wording	Amendment Detail	1st Reading	2nd Reading	3rd Reading
	<p>9.1 An abutting retailer may make application to the Licensing Inspector for a permit to conduct a sidewalk sale of goods, beverage and food products. An application for such a permit shall be on a form prescribed by the Licensing Inspector and contain:</p>	<p>Amend as follows: 9.1 An abutting retailer may make application to the Licensing Inspector for a permit to conduct a sidewalk sale of goods, beverages and/or food products for no more than two (2) days in a week. An application for such a permit shall be on a form prescribed by the Licensing Inspector and contain:</p>			
	<p>9.2(a) The Downtown Business Association or the Chamber of Commerce may make application to the Licensing Inspector to hold sidewalk sales for the months of June, July, August and September as long as Subsection 7.1, 7.2, 7.3, 7.4, and 7.5 have been complied with; and</p>	<p>Amend as follows: 9.2(a) The Downtown Charlottetown Inc. or the Chamber of Commerce may make application to the Licensing Inspector to hold sidewalk sales for the months of June, July, August and September as long as Subsection 7.1, 7.2, 7.3, 7.4, and 7.5 have been complied with; and</p>			
	<p>9.5 If requested by the Licensing Inspector provide the size and proposed location of any tables, racks or other display devices to be used by the merchants for the sidewalk sales.</p> <p>9.6 Such other information as the Licensing Inspector may require.</p>	<p>Combine and reword Sections 9.5 and 9.6 as follows and renumber remaining sections: 9.5 The Applicant shall provide such other information as the Licensing Inspector may require, including the size and proposed location of any tables, racks or other display devices to be used by the merchants for the sidewalk sales.</p>			
	<p>9.7 A permit may be issued under this Bylaw to an abutting restaurant or lounge and shall permit them to hold a sidewalk sale of food and beverages with a dining-room licence only, under the <u>Liquor Control Act</u> of the Province (R.S.P.E.I. 1974, Cap. L-17), provided: (a) The provisions of Subsection 9.1 (complete), 9.2, 9.3, 9.4, 9.5, and 9.6 are followed;</p>	<p>Amended and renumbered as follows: 9.6 A permit may be issued under this Bylaw to an abutting retailer which shall permit the holding of a sidewalk sale of food and beverages, including alcoholic beverages, with a dining-room licence only, under the <u>Liquor Control Act</u> of the Province (R.S.P.E.I. 1974, Cap. L-17) in areas approved by Council south of Fitzroy Street only, provided: (a) The provisions of Subsection 9.1 (complete), 9.2, 9.3, 9.4 and 9.5 are complied with;</p>			

STREET VENDORS BYLAW

Amendment Summary	Previous Wording	Amendment Detail	1st Reading	2nd Reading	3rd Reading
	<p>(b) Council has approved the use of any areas between the sidewalk and the street;</p> <p>(c) Council has approved the closing of part or all of the travel portion of the sidewalk for a specified time;</p> <p>(d) That sidewalk sales for a licensed restaurant or lounge be permitted in those areas of the City south of Fitzroy Street;</p> <p>(e) Council shall require that an agreement be signed with the City, and Council shall consider but is not limited to the following in the agreement:</p> <ul style="list-style-type: none"> (1) liability insurance, (2) time limits for use of the street right-of-way, (3) any fees to be charged for encroachment on a street right-of-way, (4) a scaled drawing showing the location of street furniture accessories and landscaping on a street, (5) hours of operation; <p>(f) The restaurant or lounge holds a dining room licence only for the area used on the sidewalk under the <u>Liquor Control Act</u> of the Province (R.S.P.E.I. 1974, Cap. L-17);</p> <p>(g) No permit shall be issued to an abutting retailer under this Section unless:</p> <ul style="list-style-type: none"> (1) the applicant is seeking a permit to hold a sidewalk sale on a sidewalk abutting his permanent place of business; (2) the occupation of the sidewalk proposed by the applicant will not impede pedestrian traffic or block or impair the entrance to any premises abutting the area proposed to be 	<p>(b) Council has approved the use of any areas between the sidewalk and the street to be used in the sidewalk sale;</p> <p>(c) Council has approved the closing of part or all of the travel portion of the sidewalk for a specified time;</p> <p>(d) That an agreement be entered into with the City in a form approved by Council, which shall address, but is not limited to matters such as:</p> <ul style="list-style-type: none"> (1) liability insurance; (2) time limits for use of the street right-of-way; (3) any fees to be charged for encroachment on a street right-of-way; (4) a scaled drawing showing the location of street furniture accessories and landscaping on a street; and (5) hours of operation. <p>(e) The abutting retailer that holds a dining room licence pursuant to the <u>Liquor Control Act</u> of the Province (R.S.P.E.I. 1974, Cap. L-17) and that the abutting retailer shall only conduct its sale of food and beverages in the area on the sidewalk approved by Council;</p> <p>(f) That no permit shall be issued to an abutting retailer under this Section unless:</p> <ul style="list-style-type: none"> (1) the applicant is seeking a permit to hold a sidewalk sale on a sidewalk abutting his permanent place of business; (2) the occupation of the sidewalk proposed by the applicant will not impede pedestrian traffic or block or impair the entrance to any premises abutting the area proposed to be occupied by the applicant during the sidewalk sale; and (3) the size and proposed location of all tables or racks or other display devices intended to be used by the applicant during the sidewalk sale has been approved by the Licensing Inspector. 			

STREET VENDORS BYLAW

Amendment Summary	Previous Wording	Amendment Detail	1st Reading	2nd Reading	3rd Reading
	<p>occupied by the applicant during the sidewalk sale; and (3) the size and proposed location of all tables or racks or other display devices intended to be used by the applicant during the sidewalk sale has been approved by the Licensing Inspector</p>				
	<p><i>Nothing</i></p>	<p>Add new section as follows: 9.7 (a) An abutting retailer that holds a dining room licence pursuant to the <u>Liquor Control Act</u> of the Province (R.S.P.E.I. 1974, Cap. L-17) may make application to occupy a parking space(s) on Queen Street south of Grafton Street for the sale of food, grocery and beverage products from May 1 to October 31 of any year. The application shall not be made earlier than April 1 and not later than June 15 in any year. (b) Consideration of applications for licenses in any year shall be on a first received basis. Applications for licenses for spaces that are already licensed for that year shall not be considered. (c) Any license issued shall be subject to the requirement for the Applicant to enter into an agreement with the City on terms acceptable to the City, and which agreement addresses, but is not limited to the following: (1) liability insurance; (2) time limits for use of the street right-of-way; (3) any fees to be charged for encroachment on a street right-of-way; (4) a scaled drawing showing the location of street furniture accessories and landscaping on a street; (5) hours of operation and space(s) approved; (6) the design of the fence to be constructed pursuant to Section 9.7(g) of this Bylaw. (d) The Licensing Inspector may issue a license to an abutting retailer for one or more years but not more than five (5) years at a time. In determining the duration of the license to be issued, the Licensing Inspector may consider the expense to be incurred in constructing the required fencing around the space. If, at the expiration of a license, no new applications are received for a license for that space, then the license may be renewed by the Licensing</p>			

STREET VENDORS BYLAW

Amendment Summary	Previous Wording	Amendment Detail	1st Reading	2nd Reading	3rd Reading
		<p>Inspector. Council shall by resolution from time to time delete, assign new or additional spaces on Queen Street south of Grafton Street, which may be issued licenses pursuant to this Bylaw;</p> <p>(e) In determining whether to issue a license, the Licensing Inspector shall consider, but not be limited to consideration of the quality in the workmanship and materials used in the construction of the fencing and any tables and chairs, umbrellas and displays and attractiveness in the design and coloration.</p> <p>(f) The hours of operation pursuant to any license issued are from 8:00 AM to 12:00 midnight;</p> <p>(g) Every space for which a license is issued shall require the licensee to construct a metal fence around the site in accordance with the designs contained in Schedule “D”.</p>			
	<p>12.1 A person who violates or fails to comply with the provisions of this Bylaw is guilty of an offence and is liable on summary conviction to a fine of not less than \$100 and not more than \$500 and in default of payment to imprisonment for a period not exceeding 30 days.</p>	<p>Amend as follows:</p> <p>12.1 A person who violates or fails to comply with the provisions of this Bylaw is guilty of an offence and is liable on summary conviction to a fine of not less than \$100 and not more than \$500 and in default of payment to imprisonment for a period not exceeding 30 days. Each day a person so operates shall comprise a separate offence.</p>			
	<p style="text-align: center;">SCHEDULE “A”</p> <p style="text-align: center;">DESIGNATED PUSH CART AREA</p> <p>On specific street corners and parking meter spaces as designated by resolution of City Council - otherwise it is prohibited.</p> <p style="text-align: center;"><u>STREET VENDORS - SITES</u></p> <ol style="list-style-type: none"> 1. Northeast corner of Pownal and Richmond Streets - Meter space number 67. 2. Canadian Imperial Bank of Commerce corner being the corner of Grafton and Queen Streets. The stand shall be located on the Grafton Street side in the parking meter spot close to the corner - Meter space number 56. 	<p style="text-align: center;">SCHEDULE “A”</p> <p style="text-align: center;">DESIGNATED PUSH CART AREA</p> <p>On specific street corners and parking meter spaces as designated by resolution of City Council – otherwise, it is prohibited.</p> <p style="text-align: center;"><u>STREET VENDORS - SITES</u></p> <p>See attached map for designated parking spaces</p> <ol style="list-style-type: none"> 1. Northwest corner of Queen and Grafton Streets intersection with space allocated on the Grafton Street side 2. Northeast corner of Queen and Richmond Streets intersection with space allocated on Queen Street 3. Southeast corner of University Avenue and Kent Street intersection with space allocated on Kent Street 4. Southeast corner of Queen and Kent Streets intersection with space allocated on Kent Street 			

STREET VENDORS BYLAW

Amendment Summary	Previous Wording	Amendment Detail	1st Reading	2nd Reading	3rd Reading															
	<p>3. Southeast corner of Richmond and Great George Streets.</p> <p>4. Northeast corner of Queen and Richmond Streets - Meter space number 25.</p> <p>5. Kent and University Avenue - H.F. Trust - Meter space number 26.</p> <p>6. Queen and Kent Streets - Toronto Dominion Bank - Meter space number 11.</p> <p>7. Northwest corner of Queen and Water Streets - Meter space number 139.</p>																			
	<p style="text-align: center;">SCHEDULE "B" LICENSE FEE</p> <table border="0" style="width: 100%;"> <tr> <td style="text-align: center; width: 30%;"><u>All Articles</u></td> <td style="text-align: center; width: 30%;"><u>Confectionery</u></td> <td style="width: 40%;"></td> </tr> <tr> <td>1. Push Cart \$600.00</td> <td>\$25.00 per tricycle</td> <td></td> </tr> </table>	<u>All Articles</u>	<u>Confectionery</u>		1. Push Cart \$600.00	\$25.00 per tricycle		<p style="text-align: center;">SCHEDULE "B" LICENSE FEE PER YEAR</p> <table border="0" style="width: 100%;"> <tr> <td style="width: 30%;">1. Push Cart per space</td> <td style="width: 30%;"></td> <td style="width: 40%; text-align: right;">\$600.00</td> </tr> <tr> <td>2. Street Vending per parking space</td> <td></td> <td style="text-align: right;">\$600.00</td> </tr> <tr> <td>3. Confectionary per tricycle</td> <td></td> <td style="text-align: right;">\$ 25.00</td> </tr> </table>	1. Push Cart per space		\$600.00	2. Street Vending per parking space		\$600.00	3. Confectionary per tricycle		\$ 25.00			
<u>All Articles</u>	<u>Confectionery</u>																			
1. Push Cart \$600.00	\$25.00 per tricycle																			
1. Push Cart per space		\$600.00																		
2. Street Vending per parking space		\$600.00																		
3. Confectionary per tricycle		\$ 25.00																		
	<p style="text-align: center;">APPLICATION FOR STREET VENDORS LICENSE (second page)</p> <p>The applicant acknowledges that he/she has read the Street Vendors Bylaw in its entirety, being Bylaw No. 47.</p> <p>DATED: _____ AT: _____</p> <p>WITNESS: _____</p> <p>APPLICANT: _____</p> <p>PHOTOGRAPHS OR ARTIST CONCEPT ATTACHED (AS PER BYLAW) OF CONFECTIONERY TRICYCLE, OR PUSH CART. THREE (3) PHOTOGRAPHS OF THE APPLICANT ATTACHED (AS PER BYLAW).</p>	<p>Amended as follows:</p> <p style="text-align: center;">APPLICATION FOR STREET VENDORS LICENSE (second page)</p> <p>The applicant acknowledges that he/she has read the Street Vendors Bylaw in its entirety.</p> <p>DATED: _____ AT: _____</p> <p>WITNESS: _____ APPLICANT: _____</p> <p>PHOTOGRAPHS OR ARTIST CONCEPT ATTACHED (AS PER BYLAW) OF CONFECTIONERY TRICYCLE, PUSH CART OR PARKING SPACE FOR A RESTAURANT, ABUTTING RETAILER OR LOUNGE. THREE (3) PHOTOGRAPHS OF THE APPLICANT ATTACHED (AS PER BYLAW).</p>																		
<p>To amend by deleting Schedule "A" and replacing with new schedule</p>	<p>Section "A" ...</p> <p>2. Northeast corner of Queen and Richmond Streets intersection with space allocated on Queen Street</p>	<p>Amend as follows:</p> <p>2. Space in front of 72-74 Queen Street as shown on map below and also shown as parking space # 81 on Schedule "D"</p>	<p>10-Nov-08</p>	<p>10-Nov-08</p>	<p>08-Dec-08</p>															

STREET VENDORS BYLAW

Amendment Summary	Previous Wording	Amendment Detail	1st Reading	2 nd Reading	3 rd Reading
<p>To amend the geographical area for patios, set number of parking spaces to use, definitions of food trucks, carts, mobile canteen, etc; new application process for licenses.</p>	<p>2.7"Designated Push Cart Areas" means those areas within the City designated in Schedule "A" of this Bylaw as areas in which the selling of food and/or beverages from a push cart is permitted;</p> <p>2.13"Push Cart Vendor" means any person who owns and operates or has operated for him a push cart from which food and/or beverages may be sold;</p> <p>Part V 5.25 A push cart vendor who has been issued a license under this Bylaw may sell those goods specified in that license from a push cart for which a license plate has been issued under this Bylaw in the following places within the City but in no other</p> <p>(a) From the space in the designated push cart areas allotted to him by the Licensing Inspector under Schedule "A" of the by-law.</p>	<p>Part II: Definitions Added</p> <p>2.2"Abutting Retailer – Dining Room License Space(s)" means a total of 24 parking spaces, approved by Council, available for consideration of applications for the installation of exterior decks in the area approved under section 9.7 (a).</p> <p>2.8"Designated Push Cart/Food Truck Areas" means those areas within the City designated in Schedule "A" of this Bylaw as areas in which the selling of food and/or beverages from a push cart or food truck is permitted;</p> <p>2.11"Food Truck/Mobile Canteen" means is a motor-powered vehicle, not a trailer, which is no greater than 10 metres in length (33 feet), by 2.6 metres in width (8.5 feet), by 4.3 metres in height (14 feet).</p> <p>2.15"Push Cart/Food Truck Vendor" means any person who owns and operates or has operated for him a push cart/food truck from which food and/or beverages may be sold;</p> <p>5.25 A push cart or food truck vendor who has been issued a license under this Bylaw may sell those goods specified in that license from a push cart or food truck for which a license has been issued under this Bylaw in the following places within the City but in no other: (a)From the space in the designated push cart/food truck areas allotted to him by the Licensing Inspector under Schedule "A" of the by-law</p>	<p>14-Apr-14</p>	<p>14-Apr-14</p>	<p>08-May-14</p>

STREET VENDORS BYLAW

Amendment Summary	Previous Wording	Amendment Detail	1st Reading	2nd Reading	3rd Reading
	<p>6.2 A push cart vendor who has been issued a license under this Bylaw shall:</p> <p>(a) Use only a push cart specified in a license issued to him under this Bylaw;</p> <p>(c) Not vend between 2:30 a.m. and 10:00 a.m. on any day;</p> <p>(d) Not leave any push cart unattended during business hours;</p> <p>(e) Not store, park or leave any push cart overnight on any street other than on the pedestrian mall; and not propel the cart after dusk unless equipped with reflector tape and lights;</p> <p>(h) Not allow anything relating to the operation of his business to be placed anywhere other than in, on or under the push cart;</p> <p>(i) Not set up, maintain or permit the use of any table, crate, carton, rack or any other device to increase the selling or display capacity of his push cart unless the device has been referred to in his application for a license under this Bylaw and has been approved by the Licensing Inspector for use in conjunction with the push cart;</p> <p>(m) Not sell or otherwise dispose of any goods elsewhere than on the curb side of the push cart or on the side of the push cart nearest the boundary of the street if there is no sidewalk</p> <p>(n) Keep the push cart in good repair and appearance; and</p>	<p>6.2 A push cart or food truck vendor who has been issued a license under this Bylaw shall:</p> <p>(a) Use only a push cart or food truck specified in a license issued to him under this Bylaw;</p> <p>(c) Not vend between 12:01 a.m. and 10:00 a.m. on any day;</p> <p>(d) Not leave any push cart or food truck unattended during business hours;</p> <p>(e) Not store, park or leave any push cart or food truck overnight on any street other than on the pedestrian mall; and not propel the push cart after dusk unless equipped with reflector tape and lights;</p> <p>(h) Not allow anything relating to the operation of his business to be placed anywhere other than in, on or under the push cart or food truck;</p> <p>(i) Not set up, maintain or permit the use of any table, crate, carton, rack or any other device to increase the selling or display capacity of his push cart or food truck unless the device has been referred to in his application for a license under this Bylaw and has been approved by the Licensing Inspector for use in conjunction with the push cart or food truck;</p> <p>(m) Not sell or otherwise dispose of any goods elsewhere than on the curb side of the push cart or food truck or on the side of the push cart or food truck nearest the boundary of the street if there is no sidewalk;</p> <p>(n) Keep the push cart or food truck in good repair and appearance; and</p>			

STREET VENDORS BYLAW

STREET VENDORS BYLAW

Amendment Summary	Previous Wording	Amendment Detail	1st Reading	2nd Reading	3rd Reading
	<p>7.2 An applicant for a license under this Bylaw shall make a separate written application to the Licensing Inspector for each confectionery tricycle or push cart, as the case may be, which he intends to operate or which he intends to have operated for him.</p> <p>7.3(c) A full description, and a photograph or an artist's concept, of any confectionery tricycle or push cart, for which a license plate is sought together with the serial and registration number, if any, of the vehicle;</p> <p>(d) Three prints of a full-faced photograph of the applicant taken not more than 30 days prior to the date of the application.</p> <p>(f) The designated push cart areas in which the applicant would prefer to carry on business;</p> <p>7.4 All applications for licenses shall be made after January 1 of each year to carry on a business under this by-law.</p>	<p>(p) In the case of a food truck ensure that the provisions of the Highway Traffic Act and the Motor Vehicle Inspection Regulations are met and maintained.</p> <p>7.2 An applicant for a license under this Bylaw shall make a separate written application to the Licensing Inspector for each confectionery tricycle, push cart or food truck, as the case may be, which he intends to operate or which he intends to have operated for him.</p> <p>(c) A full description, and a photograph or an artist's concept, of any confectionery tricycle, push cart or food truck, for which a license is sought together with the serial and registration number, if any, of the vehicle;</p> <p>(d) Three prints of a full-faced photograph of the applicant and employee(s) taken not more than 30 days prior to the date of the application.</p> <p>(f) The designated push cart/food truck areas in which the applicant would prefer to carry on business;</p> <p>7.4 All applications for licenses shall be made after January 1, but before February 15 of each year to carry on a business under this by-law.</p>			

STREET VENDORS BYLAW

Amendment Summary	Previous Wording	Amendment Detail	1st Reading	2nd Reading	3rd Reading
	<p>7.5(b) Where applicable, the size and design of the confectionery tricycle, push cart sought to be licensed by the applicant has been approved by the Licensing Inspector;</p> <p>(d) The Fire Inspector of the City certifies, in writing to the Licensing Inspector, that he has inspected a push cart sought to be licensed under this Bylaw and it complies with all applicable fire standards;</p> <p>(g) Where any person applies for a license for a confectionery tricycle, the applicant agrees in writing to the City to accept full responsibility for any employee or agents who may operate the tricycle without looking to those employees or agents who may operate the tricycle without looking to those employees or agents or their parents or guardians for financial responsibility for negligence. Further, the applicant must agree, in writing, to indemnify and hold harmless the employee or agent or his parent or guardian in the event that a claim for negligence is made against the employee or agent or his parent or guardian;</p> <p>7.7 A license to sell food and/or beverages from a push cart issued in accordance with this Bylaw shall only permit the holder thereof to operate from a location specified on that license the push cart identified in that license for the display and sale of the goods described in that license.</p>	<p>7.5(b) Where applicable, the size and design of the confectionery tricycle, push cart or food truck sought to be licensed by the applicant has been approved by the Licensing Inspector;</p> <p>(d) The Fire Inspector of the City certifies, in writing to the Licensing Inspector, that he has inspected a push cart/food truck sought to be licensed under this Bylaw and it complies with all applicable fire standards;</p> <p>(g) A Hold Harmless Agreement has been completed and signed for any license issued to operate on City Property. Which stipulates the applicant agrees to save harmless the City of Charlottetown, from and against any and all claims, including, without limitation, all claims for death, bodily injury or property damage, arising from any act or omission of the vendor or any assignee, agent, contractor, servant, employee, invitee or licensee of the vendor and from and against all costs, counsel fees, expenses and liabilities incurred in connection with any such claim or any action or proceeding brought thereon related to the event.</p> <p>7.7 A license to sell food and/or beverages from a push cart/food truck issued in accordance with this Bylaw shall only permit the holder thereof to operate from a location specified on that license for the display and sale of the goods described in that license.</p>			

STREET VENDORS BYLAW

Amendment Summary	Previous Wording	Amendment Detail	1st Reading	2nd Reading	3rd Reading
	<p>8.1 If, in any year, the Licensing Inspector receives more applications from push cart vendors than there are spaces established for push carts in designated push cart areas, then the Licensing Inspector shall issue only as many licenses as there are such spaces to those applicants who have complied with all the applicable requirements of this Bylaw for the issuance of the license sought with students returning to school to be given the highest priority and then in the order of the date of receipt of applications.</p> <p>For the issuance of licenses, the following shall apply: subsequent to March 01 and prior to March 15 of any year, applications complying with this Bylaw received on or prior to March 01 shall be reviewed and consideration of issuance of licenses shall be on the following basis:</p> <p>(d) Consideration of licenses received after March 15 of any year shall be on an as-received basis and the above criteria may apply.</p> <p>(b) Where applicable, specify the allocated space of the licensee within the pedestrian mall or designated push cart areas;</p> <p>8.4 The license issued under this Bylaw shall be deemed to be in force from the 1st day of April in any year to the 1st day of December in the same year.</p>	<p>8.1 If, in any year, the Licensing Inspector receives more applications from push cart/food truck vendors than there are spaces established for push carts/food trucks in designated push cart/food truck areas, then the Licensing Inspector shall issue only as many licenses as there are such spaces to those applicants who have complied with all the applicable requirements of this Bylaw for the issuance of the license, based on priorities outlined in 8.1 (a) through (c).</p> <p>For the issuance of licenses, the following shall apply: applications received between January 1 and Feb 15, shall be reviewed and those complying with this Bylaw will be given consideration for a license based on the following:</p> <p>Part VIII, Section 8.1 (d) is deleted (added in 8.1) Should the number of applications exceed the approved number of spaces, a lottery will be held based on each of the priority levels (if needed) to allocate the licenses, based on one lottery ticket per application. Where a lottery is required, all applicants shall be advised in advance of the date, time and place of the lottery.</p> <p>(b) Where applicable, specify the allocated space of the licensee within the pedestrian mall or designated push cart/food truck areas;</p> <p>8.4 The license issued under this Bylaw shall be deemed to be in force from the 1st -day of April in the year of issue to the last day of December in the following year, provided the applicant has indicated their desire to renew the license and has paid the appropriate fee, prior to Feb 15th of the year of expiry.</p>			

STREET VENDORS BYLAW

Amendment Summary	Previous Wording	Amendment Detail	1st Reading	2nd Reading	3rd Reading
	<p>8.6 A license issued under this Bylaw is not transferable or assignable</p> <p>8.7 Every licensee who has employed persons to operate a confectionery tricycle or push cart for which a license plate has been issued under this Bylaw shall:</p> <p>9.7(a) An abutting retailer that holds a dining room licence pursuant to the Liquor Control Act of the Province (R.S.P.E.I. 1974, Cap. L-17) may make application to occupy a parking space(s) on Queen Street south of Grafton Street for the sale of food, grocery and beverage products from May 1 to October 31 of any year. The application shall not be made earlier than April 1 and not later than June 15 in any year.</p> <p>9.7(b) Consideration of applications for licenses in any year shall be on a first received basis. Applications for licenses for spaces that are already licensed for that year shall not be considered</p>	<p>8.6 A license issued under this Bylaw is not transferable or assignable or eligible for resale.</p> <p>8.7 Every licensee who has employed persons to operate a confectionery tricycle, push cart or food truck for which a license has been issued under this Bylaw</p> <p>9.7(a) An abutting retailer that holds a dining room licence pursuant to the Liquor Control Act of the Province (R.S.P.E.I. 1974, Cap. L-17) may make application to occupy a parking space(s), that about their facility, in the area bounded by; Pownal Street to the west, Hillsborough Street to the east and Fitzroy Street to the north; for the sale of food and beverage products from May 1 to October 31 of any year.</p> <p>All applications for licenses shall be made after January 1, but before February 15 of each year to carry on a business under this by-law. Establishments that are situated on a corner, with frontage on two streets, may apply for decks on both streets, however these would be applications. Subject to the reviewing authority, a maximum of three spaces may be considered in any application.</p> <p>A license issued under this Bylaw shall be deemed to be in force from the 1st day of April in the year of issue to the last day of December in the two years following, provided the applicant has indicated their desire to renew the license and has paid the appropriate fee, prior to Feb 15th of the subsequent years.</p> <p>For the purposes of clarification of subsection (a) and (b), those licenses held or approved in 2013, remain in force and effect to December 31st, 2015. Any new licenses approved in 2014 will also remain in force and effect until December 31st 2015.</p> <p>9.7(b) Consideration of applications for licenses in any year shall be on a first received basis. Applications for licenses for spaces that are already licensed for that year shall not be considered. Should the number of applications exceed the approved number of spaces, a lottery will be held to allocate the licenses, based on one lottery ticket per application. Where a lottery is required, all applicants shall be advised in advance of the date, time and place of the lottery.</p>			

STREET VENDORS BYLAW

Amendment Summary	Previous Wording	Amendment Detail	1st Reading	2nd Reading	3rd Reading
	<p>9.7(d) The Licensing Inspector may issue a license to an abutting retailer for one or more years but not more than five (5) years at a time...</p> <p>Schedule "A" DESIGNATED PUSH CART AREA</p> <p>On specific street corners and parking meter spaces as designated by resolution of City Council – otherwise, it is prohibited.</p> <p>STREET VENDORS - SITES See attached map for designated parking spaces</p> <ol style="list-style-type: none"> 1. Northwest corner of Queen and Grafton Streets intersection with space allocated on the Grafton Street side 2. Space in front of 72-74 Queen Street as shown on map below and also shown as parking space # 81 on Schedule "D" 3. Southeast corner of University Avenue and Kent Street intersection with space allocated on Kent Street 4. Southeast corner of Queen and Kent Streets intersection with space allocated on Kent Street 	<p>9.7(d) The Licensing Inspector may issue a license to an abutting retailer for one or more years but not more than three (3) years at a time.</p> <p>Schedule "A" DESIGNATED PUSH CART/FOOD TRUCK AREAS</p> <p>On specific street corners and parking meter spaces as designated by this Bylaw – otherwise, it is prohibited.</p> <p>STREET VENDORS – PUSH CART SITES See attached map for designated parking spaces</p> <p>Space 1. Single space on the southeast corner of Queen and Kent Streets intersection. Space allocated on Kent Street in parking meter space # 10R.</p> <p>Space 2. Single space on the northeast corner of Queen and Richmond Streets intersection. Space allocated on Queen Street in parking meter space # 22.</p> <p>Space 3. Single space on the southeast corner of University Avenue and Kent Street intersection. Space allocated on Kent Street in parking meter space # 24.</p>			

STREET VENDORS BYLAW

Amendment Summary	Previous Wording	Amendment Detail	1st Reading	2nd Reading	3rd Reading
	<p>SCHEDULE "B" LICENSE FEE PER YEAR 1. Push Cart per space \$600.00 2. Street Vending per parking space \$600.00 3. Confectionary per tricycle \$25.00</p> <p>SCHEDULE "C" – Check List Push carts, and tricycles 2. Full description and a photograph or an artist's concept of any confectionery tricycle, or push cart.</p>	<p>SCHEDULE "A" DESIGNATED PUSH CART/FOOD TRUCK AREAS</p> <p>On specific street corners and parking meter spaces as designated by this Bylaw – otherwise, it is prohibited.</p> <p>STREET VENDORS – PUSH CART SITES See attached map for designated parking spaces</p> <p style="padding-left: 40px;">Space 1. Single space on the southeast corner of Queen and Kent Streets intersection. Space allocated on Kent Street in parking meter space # 10R.</p> <p style="padding-left: 40px;">Space 2. Single space on the northeast corner of Queen and Richmond Streets intersection. Space allocated on Queen Street in parking meter space # 22.</p> <p style="padding-left: 40px;">Space 3. Single space on the southeast corner of University Avenue and Kent Street intersection. Space allocated on Kent Street in parking meter space # 24</p> <p>SCHEDULE "B" LICENSE FEE PER YEAR 1. Push Cart per space \$ 600.00 2. Food Truck per space \$1,200.00 (Apr-Dec) 3. Food Truck per space \$1,600.00 (Year Round) 4. Street Vending per parking space \$ 600.00 5. Confectionary per tricycle \$ 25.00 6. Restaurant – Abutting Retailer or Lounge \$600.00 per parking space</p> <p>SCHEDULE "C" – Check List Push carts, food trucks and tricycles 2. Full description and a photograph or an artist's concept of any confectionery tricycle, push cart or food truck.</p>			

STREET VENDORS BYLAW

Amendment Summary	Previous Wording	Amendment Detail	1st Reading	2nd Reading	3rd Reading
	5. Tricycles: (a) Under 12 ± Parental Consent Employer Indemnity 7. Permits: (a) Push Carts (i) Public Health (b) Tricycles (i) Public Health	5. Confectionary Tricycles: (a) Over 12 Under 16 Parental Consent Employer Indemnity 7. Permits: (a) Push Carts (i) Public Health Electrical (b) Food Trucks (i) Public Health (b) Tricycles (i) Public Health			

STREET VENDORS BYLAW

Amendment Summary	Previous Wording	Amendment Detail	1st Reading	2nd Reading	3rd Reading
Amend Part VI Section 6.2(f), 6.2(g) & 6.2(p)	<p>6.2(f) becomes 6.2(g) after amendments 6.2 (f) In the case of a food truck ensure that the provisions of the Highway Traffic Act and the Motor Vehicle Inspection Regulations are met and maintained.</p> <p>6.2(o) Maintain any insurance required by this Bylaw in full force and effort during the currency of any license issued to him hereunder.</p> <p>6.2(p) Maintain any insurance required by this Bylaw in full force and effort during the currency of any license issued to him hereunder.</p>	<p>6.2(f) Effective September 1, 2015, Non-styro foam packaging and cups must be used for serving containers.</p> <p>6.2(g) Not sell food products for immediate consumption unless he has available for public use his own or a public litter receptacle which is available for his customers' use. Recycling receptacles must be provided for any packaging that is recyclable, if present.</p> <p>6.2(p) Any electrical generator must be self-contained and not have a decibel output exceeding 70 Db, which shall not exceed 60 Db when tested on the property of the nearest potential complainant.</p> <p>6.2(o) & 6.2(p) lettered as 6.2(q) & 6.2(r), respectively however the wording remains the same as in previous bylaw</p>	13-Apr-15	13-Apr-15	11-May-15

STREET VENDORS BYLAW

Amendment Summary	Previous Wording	Amendment Detail	1st Reading	2nd Reading	3rd Reading
Amend Part VI Section 6.2(c)	6.2(c) Not vend between 12:01 a.m. and 10:00 a.m. on any day; (was 2:30 AM)	6.2(c) Be free to operate at any hour, except where the location is in a residential area (Schedule “A” Food Truck – Space #3) which shall not vend between 12:01 a.m. and 10:00 a.m. on any day;	28-May-15	28-May-15	29-May-15
Schedule “A” – Space 1	Space(s) on the northwest corner of Queen and Grafton Streets intersection. Space(s) allocated on Grafton Street in parking meter space # 54 L & R.	Space(s) on the northwest corner of Queen and Grafton Streets intersection. Space(s) allocated on Grafton Street in parking meter space # 23 L & R			
Schedule “A” – Space 3	Space(s) on the southeast corner of Water St. and Great George St.	Space(s) on the southeast corner of Water St. and Great George St. (restricted hours, shall not vend on any day between 12:01 am and 10:00 am)			